



Southwire™

# TOOLS & EQUIPMENT

CATALOG



**BUILT FOR DURABILITY.  
BUILT FOR RELIABILITY.  
BUILT FOR WORK.™**

[SOUTHWIRE.COM](http://SOUTHWIRE.COM)





# ***THE COMPLETE SOUTHWIRE® SOLUTION***

**WIRE AND CABLE | TOOLS AND EQUIPMENT | POWER MANAGEMENT  
ELECTRICAL COMPONENTS | LIGHTING SOLUTIONS**





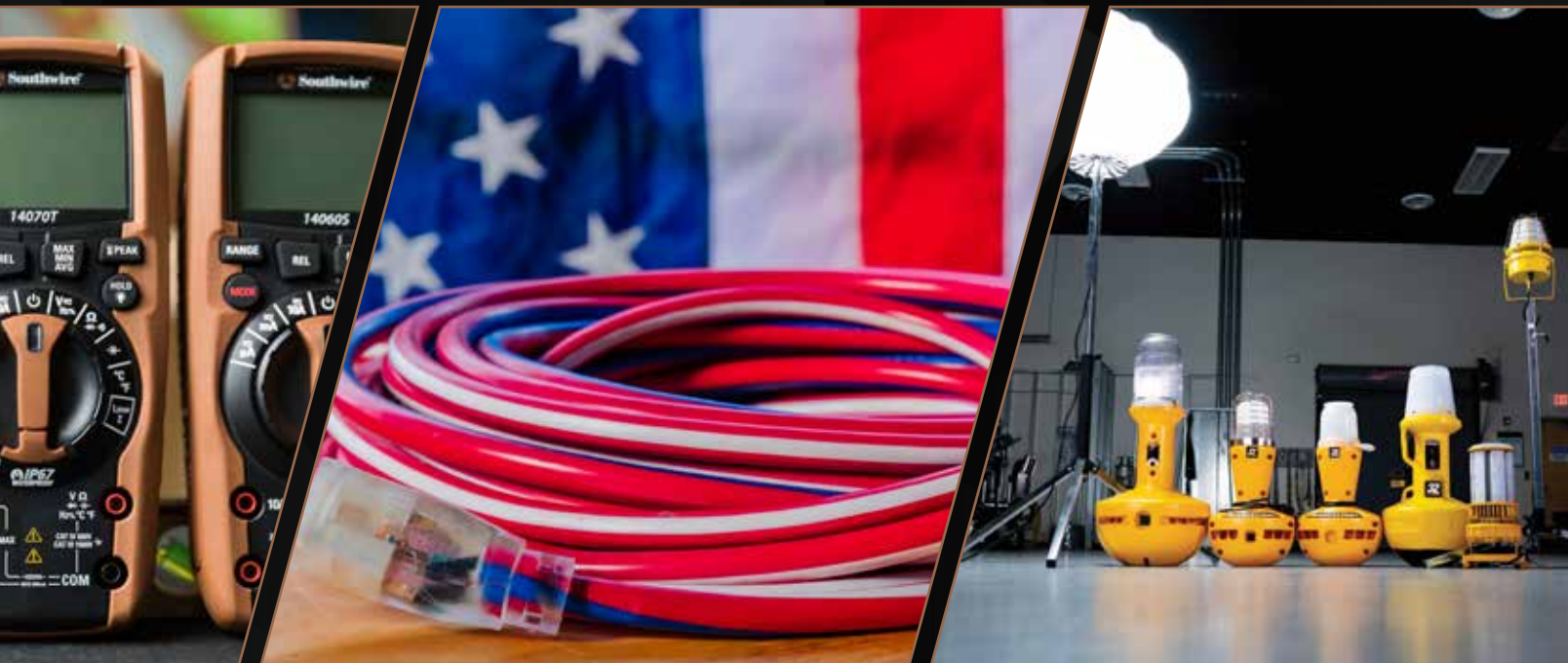

# OUR STORY

As a family business, Southwire proudly continues building on our commitment to environmental stewardship and corporate sustainability by prioritizing stakeholder expectations, and supporting the wellbeing of our communities and the environment in which we live. To help us meet this commitment, we organize our sustainability strategy around five core tenets: Growing Green, Living Well, Giving Back, Doing Right, and Building Worth.

## ***We Deliver Power...Responsibly®***

We remain committed to the sustainability of our company for the next 100 years and beyond. As we strengthen this commitment, we continue to work hard every day to discover, develop and distribute sustainable solutions that exceed the expectations of our stakeholders around the world.

## **OUR MISSION**

To be a **preferred provider** of solutions to the electrical industry by providing innovative products and services with exceptional quality.

## **OUR VALUES**

Our **ONE Southwire** culture prioritizes the interests of our team members, customers, and communities through a continuous commitment to empowerment, trust, consistency, and inclusion.

## **OUR REACH**

Nearly one in two new homes built in the United States contains our wire, and we produce half of the cable used to transmit and distribute electricity throughout the nation.

## **OUR PRODUCTS**

Our product teams and dedicated resources work together to listen to and work with our customers, creating solutions that deliver unparalleled value through product innovation, safety and efficiency.

## **OUR SERVICE**

Service is more than a word or a phone number; it's a tangible support system that assists you through the entire project cycle; from our knowledgeable customer service team, to our experienced field sales team, we're there every step of the way.





# TABLE OF CONTENTS

## HAND TOOLS

Pliers.....	7
Wounded Warrior Project® Limited Edition Pliers.....	14
Wounded Warrior Project® Limited Edition Wire Strippers.....	15
Stripping & Cutting .....	16
Cutters .....	18
Electrician Hammers .....	20
Wounded Warrior Project® Limited Edition Cutters .....	21
Blades.....	23
Knives.....	25
Drivers .....	26
Hex Keys.....	36
Levels .....	37
Bags.....	38
Accessories .....	40
Kits.....	41

## FISHING & BENDING

SIMpull™ Fishtapes.....	47
Stainless Steel Fishtapes .....	50
Steel Fishtapes.....	51
Fish Sticks .....	52
Conduit Hand Benders.....	53

## TEST & MEASUREMENT

Multimeters .....	62
Clamp Meters .....	72
Voltage Testers.....	78
NCVs .....	81
Testers.....	86
IR Thermometers .....	89
Test Kits.....	91

## VOICE • DATA • VIDEO

Test Set .....	97
Mappers & Testers .....	98
Phone Outlet Tester .....	101
Data & Video Cable Tester.....	102
Tone & Probe Kit.....	103
Cutters .....	105
Cutting & Stripping .....	106
Prep Tool .....	107
Punch Down Tools.....	108
Crimping Tools.....	109

## CABLE PULLING

Pullers.....	115
Pulling Accessories .....	122
Pulling Rope.....	125
Conduit Measuring Tape.....	128
Pulling Grips .....	129
Reel Rollers .....	136
Accessories .....	137

## TERMINATION

Cable Strippers.....	139
----------------------	-----

## CONDUIT BENDING

Benders .....	142
PVC Blankets .....	149
Plug Kits.....	150

## HOLE MAKING

Knockouts.....	152
Layout Tool .....	158
Drive Units .....	159
Hole Saws.....	160
Auger Bits .....	161
Drill Bits .....	164

## MATERIAL HANDLING

Flange.....	167
Reel Stands .....	168
Axle & Riser .....	172
Pallet Jacks .....	173
SIMpull™ CoilPak™ Utility Carts.....	174
SIMpull™ Barrel™ Hand Truck & Tripod....	175
Wire Wagon® Carts .....	176
Wire Carts.....	179
Caddy Mac™ .....	180
Caddies .....	182
Mac Racks™ I & Mac Racks™ II .....	183
Hanger Mac™ .....	184
Pipe Mac™ & Bundle Mac™ .....	185
Stor Mac™ Storage Cabinets .....	186
Tainer Mac™ .....	188
Weldbox™ .....	189
Cabinets.....	190
Piano Boxes.....	191
Field Office .....	192
Compact Chests.....	193
Utility Carts .....	194



# HAND TOOLS

---

Your hands are your most valuable asset on the job. That's why we're here to equip them with high-quality, durable hand tools from Southwire. With a strong yet comfortable design and no-hassle lifetime warranty, you can rely on these tools to make your life easier and last through years of hard work.





# HAND TOOLS

## HIGH LEVERAGE SIDE CUTTING PLIERS

**SCP9TPCB**



**SCP9TPC**



**SCP9C**



**SCP9**



**SCP9D**



**SCP9CD**



Our high leverage side cutting pliers offer a streamlined design with sure-gripping, cross-hatched knurled jaws.

- Induction-hardened cutting blades ensure efficient and lasting cutting surfaces for hard and soft wire
- Drop forged CRV steel for durability
- File teeth on jaws help remove burrs in conduit
- Curved ergonomic handle for comfortable use

## SPECIFICATIONS

MODEL #	STOCK #	DESCRIPTION		
SCP9TPC	58993140	High Leverage Side Cutting Pliers w/ Fish Tape Puller & Crimper		
SCP9C	58993040	High Leverage Side Cutting Pliers w/ Crimper		
SCP9	58992940	High Leverage Side Cutting Pliers		
SCP9TPCB	65028940	High Leverage Side Cutting Combo Pliers		
	HEIGHT	WIDTH	DEPTH	WEIGHT
SCP9TPC	9.5"	2.5"	0.88"	1.19 lbs
SCP9C	9.5"	2.5"	0.88"	1.19 lbs
SCP9	9.5"	2.5"	0.88"	1.19 lbs
SCP9TPCB	9.00"	2.5"	0.79"	1.16 lbs

MODEL #	STOCK #	DESCRIPTION		
SCP9D	58289840	High Leverage Diagonal Cutting Pliers w/ Dipped Handle		
SCP9CD	58749140	High Leverage Diagonal Cutting Pliers w/ Crimper Dipped Handles		
	HEIGHT	WIDTH	DEPTH	WEIGHT
SCP9D	9.5"	2.13"	0.75"	1.19 lbs
SCP9CD	9.5"	2.13"	0.75"	1.19 lbs



HAND TOOLS | PLIERS



# HAND TOOLS

## LONG NOSE PLIERS

**LNP8SD**



**LNP7D**



Southwire long nose pliers provide a better grip without sacrificing tool strength or durability.

- Knurled jaws for sure-gripping
- Drop forged CRV steel for durability
- High leverage, hot rivet design for smooth action and no handle wobble
- Long nose design for forming and looping wire and handling small parts
- Precision induction-hardened cutting knives for long-lasting cutting edge
- 12 AWG solid wire stripper on LNP8SD

## SPECIFICATIONS

MODEL #	STOCK #	DESCRIPTION		
LNP8SD	58289740	8" Hvy. Dty. Long Nose Pliers Side Cutting Stripper Dipped Handle		
LNP7D	58749040	7" Long Nose Pliers w/ Side Cut Dipped Handle		
	HEIGHT	WIDTH	DEPTH	WEIGHT
LNP8SD	8.38"	2.13"	0.63"	0.64 lbs
LNP7D	7.38"	2.13"	0.63"	0.38 lbs

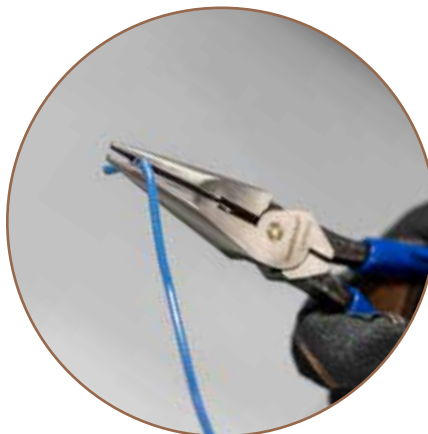



# HAND TOOLS

## HIGH LEVERAGE DIAGONAL CUTTING PLIERS

**DCP8**



**DCPA8**



The high leverage design of these diagonal cutting pliers provides greater cutting power while the hot riveted joint ensures smooth action with no handle wobble.

- Drop forged CRV steel for durability
- Induction hardened cutting blades ensure efficient and lasting cutting surfaces
- High leverage design provides maximum cutting power
- Hot riveted pivot joint provides smooth action and no wobble
- Effectively cuts most hardened wire, ACSR, bolts, screws, and nails
- Available in dual molded comfort grips and plastic dipped handles



*\*DCPA8 and DCPA8D*

## SPECIFICATIONS

**DCP8D**



**DCPA8D**



MODEL #	STOCK #	DESCRIPTION		
DCP8	58993340	8" High Leverage Diagonal Cutting Pliers		
DCPA8	58993240	8" High Leverage Diagonal Cutting Pliers w/ Angled Head		
	HEIGHT	WIDTH	DEPTH	WEIGHT
DCP8	8.25"	2.25"	0.75"	0.73 lbs
DCPA8	8.25"	2.25"	0.75"	0.73 lbs

MODEL #	STOCK #	DESCRIPTION		
DCP8D	58289440	8" High Leverage Diagonal Cutting Pliers w/ Dipped Handle		
DCPA8D	58289540	8" High Leverage Diagonal Cutting Pliers w/ Angled Head and Dipped Handle		
	HEIGHT	WIDTH	DEPTH	WEIGHT
DCP8D	8"	2"	0.63"	0.61 lbs
DCPA8D	8"	2"	0.63"	0.61 lbs



# HAND TOOLS

## CABLE CUTTERS

**CCP9**



**CCP9DE**



**CCPR400**



**CCP350**



**CCPR400S**



**CCP750**



**CCPR1K**



The hook jaws grab and hold cable while the shear cutting action allows for clean cuts.

- Heat treated, precision ground blades ensure clean cuts
- Comfortable cushion grips reduce hand fatigue
- Forged steel with black-oxide finish for long life
- High leverage pivot joint ensures smooth action and no handle wobble

## SPECIFICATIONS

MODEL #	STOCK #	DESCRIPTION		
CCP9	58993540	9" High Leverage Cable Cutter		
CCP350	59158540	350 MCM 16" Cable Cutter		
CCP750	58738240	750 MCM 31" Fiberglass Handle Cable Cutter		
CCPR400	58277740	750 MCM Ratcheting Cable Cutter		
CCPR400S	59556240	600 MCM Ratcheting Cable Cutter		
CCPR1K	58738340	1K MCM Ratcheting with Telescoping Handles		
	HEIGHT	WIDTH	DEPTH	WEIGHT
CCP9	9.38"	2.13"	0.63"	0.94 lbs
CCP350	18.90"	4.53"	1.18"	2.55 lbs
CCP750	31"	5.32"	1.23"	5.50 lbs
CCPR400	13.78"	6.81"	1.57"	0.51 lbs
CCPR400S	9.25"	5.71"	1.57"	1.54 lbs
CCPR1K	16.20"	7.10"	2.70"	7.33 lbs

MODEL #	STOCK #	DESCRIPTION		
CCP9DE	64323040	9" High-Leverage Cable Cutters w/ Ergonomic Dipped Handle		
	HEIGHT	WIDTH	DEPTH	WEIGHT
CCP9DE	9.25"	1.8"	0.62"	1 lbs





# HAND TOOLS

## TERMINAL CRIMPING | CUTTING PLIERS

TCC9

TCC9D



These high leverage crimping pliers have two die positions that permit the tool to crimp insulated and non-insulated terminals and ferrules.

- Tapered nose for working in confined spaces
- Crimps 10-22 AWG solderless terminals and connectors
- Specially hardened wire cutter in nose
- Curved handle and ergonomic molded grip for comfortable use
- Crimps insulated and non-insulated terminals and connectors

### SPECIFICATIONS

MODEL #	STOCK #	DESCRIPTION		
TCC9	58993640	Terminal Crimper Cutter w/ Comfort Grip Handle		
TCC9D	58289940	Terminal Crimper Cutter w/ Dipped Handle		
	HEIGHT	WIDTH	DEPTH	WEIGHT
TCC9D	9.75"	2.38"	0.63"	0.79 lbs
TCC9	9.38"	1.88"	0.75"	0.86 lbs



# HAND TOOLS

## MULTI-TOOL PLIERS

**S7N1HD**



**S816SOLHD**



**SNM1214HD**



**S5N1**



Versatile spring action pliers that perform multiple functions.

- Grip, strip, crimp, ream, shear, and cut
- Narrow knurled jaw allows access to tight spaces
- Cuts small gauge copper wire and communication cables
- Crimps common size wire ferrules
- Easily strips 10-14 AWG solid wire
- Durable forged construction for lasting performance
- Comfortable grips minimize hand wear and fatigue
- Strips:
  - S7N1HD: 10-14 AWG Solid, 12-16 Stranded
  - S816SOLHD: 8-16 AWG Solid, 10-18 Stranded
  - SNM1214HD: 12/2 and 14/2 Romex

## SPECIFICATIONS

MODEL #	STOCK #	DESCRIPTION		
S7N1HD	65028440	7-in-1 Long Nose Multi-Tool Plier		
S5N1	58993940	5-in-1 Multi-Tool Plier		
S816SOLHD	65028140	Forged Wire Stripper 8-16 AWG Solid 10-18 AWG Stranded		
SNM1214HD	65028240	Forged Romex Stripper 12-14 AWG Solid w/ Ergo Grip		
	HEIGHT	WIDTH	DEPTH	WEIGHT
S7N1HD	10.24"	3.54"	0.98"	0.79 lbs
S5N1	10.10"	3.54"	0.70"	0.65 lbs
S816SOLHD	10.24"	3.54"	0.98"	0.71 lbs
SNM1214HD	10.04"	3.54"	0.79"	0.74 lbs





# HAND TOOLS

## MULTI-PURPOSE SIDE CUTTING PLIER

**MPSCP**



Multi-purpose side cutting plier cuts ACSR, screws, nails, and most hardened wire.

- Drop forged construction for durability
- High-leverage pivot joint for easier cuts
- Strips 8-14 AWG solid and 10-16 stranded
- 6-32 and 8-32 screw shearing

### SPECIFICATIONS

MODEL #	STOCK #	DESCRIPTION		
MPSCP	59724440	Multi-Purpose Side Cutting Plier		
HEIGHT	WIDTH	DEPTH	WEIGHT	
MPSCP	11.38"	3.75"	1.50"	0.6 lbs



# HAND TOOLS

## MADE IN USA PLIERS - WOUNDED WARRIOR PROJECT®

SCP9TPCD-WW



DCPA8D-WW



Made from American forged steel, these tools are built to withstand jobsite wear and tear. Assembled with hot rivet technology, these pliers are designed to be the livelihood of every professional. Proudly supporting Wounded Warrior Project®.

- Hot riveted pivot joint for smooth action
- Induction hardened
- Hand sharpened blades
- Drop forged USA steel for durability

### SPECIFICATIONS

MODEL #	STOCK #	DESCRIPTION		
SCP9TPCD-WW	67038040	Made in USA 9" High-Leverage Side Cutting Pliers w/ Fish Tape Puller, Crimper, & Dipped Grip Handles		
DCPA8D-WW	67038340	Made in USA 8" Angled Head High-Leverage Diagonal Cutting Pliers w/ Dipped Handles		
CCP9D-WW	67038940	Made in USA 9" High-Leverage Cable Cutters w/ Dipped Grip Handles		
TCC9D-WW	67038640	Made in USA 9" Terminal Crimper/Cutter w/ Dipped Grip Handles		
	HEIGHT	WIDTH	DEPTH	WEIGHT
SCP9TPCD-WW	11.75"	3.88"	11.75"	1.1 lbs
DCPA8D-WW	10.13"	3.88"	10.13"	0.6 lbs
CCP9D-WW	11.75"	3.88"	11.75"	1.05 lbs
TCC9D-WW	11.75"	3.88"	11.75"	0.9 lbs

CCP9D-WW



TCC9D-WW



 **WE'VE GOT IT  
MADE IN AMERICA™**



WOUNDED WARRIOR PROJECT®  
LIMITED EDITION PRODUCTS

HAND TOOLS



# HAND TOOLS

## MADE IN USA WIRE STRIPPERS - WOUNDED WARRIOR PROJECT®

**S1018SOL-WW**

**S1020SOL-WW**

Made from durable, heat-treated steel, the Made in USA wire strippers & cutters are equipped to handle day-to-day jobsite demands. Proudly supporting the Wounded Warrior Project®.



- Double-dipped grip for comfortable fit
- Serrated nose holds cable for easy twisting and pulling
- Spring-loaded for self-opening action

### SPECIFICATIONS

MODEL #	STOCK #	DESCRIPTION		
S1018SOL-WW	67039540	10-18 AWG Solid Wire Stripper Ergo Handles		
S1020SOL-WW	67039240	10-20 AWG Solid Wire Stripper Compact Handles		
SNM1214HH-WW	67039840	Romex® Brand BOXJaw™ Wire Stripper		
	HEIGHT	WIDTH	DEPTH	WEIGHT
S1018SOL-WW	8.5"	4"	0.5"	0.37 lbs
S1020SOL-WW	8.5"	4"	0.5"	0.32 lbs
SNM1214HH-WW	9.75"	4"	1.5"	0.4 lbs

**SNM1214HH-WW**



 **WE'VE GOT IT  
MADE IN AMERICA™**

**HAND TOOLS** | **WOUNDED WARRIOR PROJECT®**  
LIMITED EDITION PRODUCTS

# HAND TOOLS

## WIRE STRIPPERS & CUTTERS

**S1018SOL**



**S612STR**



**S1018STR**



**S1626STR**



Made of stainless steel, these wire strippers have precision ground stripping holes and are fitted with comfortable double-dipped plastic grips.

- Stainless steel construction is durable and rust proof
- Serrated nose grasps the cable for easy twisting and pulling
- Double-dipped grip provides comfortable feel
- Spring loaded for self-opening action
- Specially designed cutting blades provide fast and clean wire stripping and cutting

### SPECIFICATIONS

MODEL #	STOCK #	DESCRIPTION		
S1018SOL	58278040	Wire Stripper Cutter 10-18SOL;12-20 Stranded Ergonomic Handle		
S1018STR	58278140	Compact Stripper Cutter 10-18 AWG Solid		
S612STR	58277940	Wire Stripper Cutter 6-12 AWG Stranded Ergonomic Handle		
S1626STR	58278240	Compact Stripper Cutter 16-26 AWG Stranded		
	HEIGHT	WIDTH	DEPTH	WEIGHT
S1018SOL	7.63"	2.38"	0.69"	0.33 lbs
S1018STR	6.25"	2.5"	0.69"	0.29 lbs
S612STR	7.38"	2.5"	0.63"	0.33 lbs
S1626STR	6.25"	2"	0.69"	0.28 lbs





# HAND TOOLS

## WIRE STRIPPERS & CUTTERS

**SNM1012**



**SNM1214**



**MP61**



**MPLN**



**SVN**



**SA822**



Made of stainless steel, these wire strippers have precision ground stripping holes and are fitted with comfortable double-dipped plastic grips.

- Stainless steel\* construction is durable and rust-proof
- Serrated nose grasps the cable for easy twisting and pulling
- Specially designed cutting blades provide fast and clean wire stripping and cutting
- Double-dipped grip provides comfortable fit
- Spring loaded for self-opening action (on models SNM1012, SNM1214)

## SPECIFICATIONS

MODEL #	STOCK #	DESCRIPTION
SNM1012	58278440	NM Cable Stripper Cutter 10-12 AWG Ergonomic Handle
SNM1214	58278540	NM Cable Stripper Cutter 12-14 AWG Ergonomic Handle
MP61	58278940	6-in-1 Multipurpose Stripper
MPLN	58278840	Long Nose Multipurpose Tool
SVN	58278740	Wire Stripper V-Notch
SA822	58278640	Automatic Wire Stripper 8-18 AWG Solid 10-20 AWG Stranded

	HEIGHT	WIDTH	DEPTH	WEIGHT
SNM1012	8.13"	2.19"	0.69"	0.36 lbs
SNM1214	7.88"	2.19"	0.69"	0.36 lbs
MP61	9"	2.38"	0.69"	0.43 lbs
MPLN	8.5"	2.38"	0.75"	0.36 lbs
SVN	5.25"	2.31"	0.44"	0.14 lbs
SA822	7"	3.38"	1.13"	0.9 lbs

\*Excludes SVN & SA822

# HAND TOOLS

## ELECTRICIAN'S SCISSORS

ES001



Unlike regular scissors or shears, the serrated blades keep wire from slipping out of the jaws, so that cutting through hardware cloth, cable, wire netting, and other difficult-to-cut materials becomes an easy task.

- Durable nickel-plated steel for resistance from rust and corrosion
- Strips 19 AWG & 23 AWG
- Scraper and file on outside of both blades

### SPECIFICATIONS

MODEL #	STOCK #	DESCRIPTION		
ES001	58283540	Electrician's Scissors		
HEIGHT	WIDTH	DEPTH	WEIGHT	
ES001	5.38"	2.19"	0.38"	0.19 lbs

## PLASTIC PIPE CUTTER

PLACUT



Our plastic pipe and tube cutter has non-slip grips and a strong stainless steel blade that makes cutting plastic tubing easy.

- Easily performs flush cuts on rigid plastic tubing
- Durable design for rugged use
- Locking latch allows easy one-handed operation
- Cuts up to 3/4" PVC and 1-5/8" flexible tubing

### SPECIFICATIONS

MODEL #	STOCK #	DESCRIPTION		
PLACUT	58282140	Plastic Pipe Cutter		
HEIGHT	WIDTH	DEPTH	WEIGHT	
PLACUT	8.75"	1.83"	1.17"	0.35 lbs

## CONDUIT SCORING AND CUTTER

### CONCUT



Cut copper, aluminum, brass tubing, and galvanized thin wall conduit quickly and cleanly in just a few revolutions.

- Scores and cuts EMT conduit
- Zinc alloy construction for long lasting use and durability
- Fold-away conduit reamer blade

### SPECIFICATIONS

MODEL #	STOCK #	DESCRIPTION	HEIGHT	WIDTH	DEPTH	WEIGHT
CONCUT	58282040	Conduit Scoring and Cutter				
CONCUT			5.118"	2.165"	1.378"	.88 lbs

## DRYWALL JAB SAW

### DESAW



Our Drywall Jab Saw is designed with a triple cut blade for a fast and efficient cut. The sharp tip excels at plunge cutting, and its aggressive tooth design cuts fast.

- Hardened and tempered steel blade
- Designed to cut through drywall, wood, or plastic
- Overmolded cushion handle for comfort and firm grip
- 7" blade with cross-ground teeth allows drywall to be cut in both directions
- Sharpened tip easily plunges through drywall

### SPECIFICATIONS

MODEL #	STOCK #	DESCRIPTION	HEIGHT	WIDTH	DEPTH	WEIGHT
DESAW	58282440	Drywall Jab Saw				
DESAW			11.81"	1.378"	1.378"	0.35 lbs



# HAND TOOLS

## ELECTRICIANS HAMMERS

**BMEH18**



Our 18 oz. Electrician's Hammer is specifically designed to easily remove Romex™ Brand Wire Staples while our 20 oz. delivers the same great quality, made with heavy duty drop forged steel.

### **ELECTRICIAN'S HAMMER 18 oz.**

- Romex™ Brand Wire Stripper Staple remover allows for easy removal of staples
- 18 oz. head constructed of heavy duty drop forged steel
- Extended neck designed for easy reach into outlet boxes
- High strength, comfort grip fiberglass handle for vibration resistance

### **ELECTRICIAN'S HAMMER 20 oz.**

- 20 oz. head constructed of heavy duty drop forged steel
- Smooth face leaves fewer marks on striking surfaces
- High strength, comfort grip fiberglass handle for vibration resistance

**BMEH20**



## SPECIFICATIONS

MODEL #	STOCK #	DESCRIPTION		
BMEH18	65116740	Electrician's Hammer 18 oz.		
BMEH20	65116840	Electrician's Hammer 20 oz.		
	HEIGHT	WIDTH	DEPTH	WEIGHT
BMEH18	14.1"	6.5"	1.5"	1.125 lbs
BMEH20	13.9"	7.1"	1.9"	1.25 lbs

# HAND TOOLS

## ROTO-SPLIT® CUTTERS - WOUNDED WARRIOR PROJECT®



**RS-101A-WW**

 **WE'VE GOT IT  
MADE IN AMERICA™**

The RS-101A-WW and MCCUT-WW will become your everyday cutters for MC Cable. They feature a thumb screw to clamp and release the cable. You'll never do another MC Cable job without it. Proudly made in the USA.

- Cuts or strips any armored cable from AWG 14/2 to 10/4, including AC, MC, BX, & HCF
- Cuts 3/8" trade size Flex
- Stores up to 6 extra blades in handle knob
- Durable die cast epoxy-enameled body

### SPECIFICATIONS

MODEL #	STOCK #	DESCRIPTION	WEIGHT	MIN OPENING	MAX OPENING	FLEX (TRADE SIZE)	AWG SOL OR MC RANGE
RS-101A-WW	66978140	RS-101A-WW Super Roto-Split® Cutter					
MCCUT-WW	66979340	BX MC Rotary Cutter w/Lever					
RS-101A-WW			1.2 lbs	0.375"	0.75"	3/8"	14/2 to 10/4
MCCUT-WW			1.2 lbs	0.375"	0.75"	3/8"	14/2 to 10/4



**RS-101AC-WW**

 **WE'VE GOT IT  
MADE IN AMERICA™**

The RS-101AC-WW features a clamping system that covers the complete cable size range without using a thumb screw. The self-tightening blade system prevents you from damaging the cable. Proudly made in the USA.

- Automatically adjusts the clamping pin to the correct diameter
- Safely cut any type of armored cable by automatically adjusting to the cable diameter
- Self-tightening blade system and ergonomic crank handle with offset for maximum hand clearance
- Stores up to 6 extra blades in handle knob
- Depth of cut adjustment for standard MC cable and smaller diameter MC cable

### SPECIFICATIONS

MODEL #	STOCK #	DESCRIPTION	WEIGHT	MIN OPENING	MAX OPENING	FLEX (TRADE SIZE)	AWG SOL OR MC RANGE
RS-101AC-WW	66978440	RS-101AC-WW Automatic Roto-Split® Cutter					
RS-101AC-WW			1.2 lbs	0.375"	0.75"	3/8"	14/2 to 10/4

**HAND TOOLS**  
WOUNDED WARRIOR PROJECT®  
LIMITED EDITION PRODUCTS

# HAND TOOLS

## ROTO-FLEX™ CUTTERS - WOUNDED WARRIOR PROJECT®



**RF-120A-WW**

 **WE'VE GOT IT  
MADE IN AMERICA™**

The RF-120A-WW provides clean cuts and does not require adjustments after the initial setting. Cutting in tight quarters is easy and fast. The self-tightening blade system prevents you from damaging the cable. The RF-120A-WW includes a blade storage cartridge in the knob with room for up to 6 spare blades. Proudly made in the USA.

- Cuts 1/2" to 3/4" flex
- Strips large AC, BX, MC cables ranging from AWG 2/3, 3/4, and 4/3
- Blade storage cartridge in knob with storage for 6 blades
- Requires no adjustment after initial setting - quick clamp lever does it all
- Die cast epoxy-enamel body

### SPECIFICATIONS

MODEL #	STOCK #	DESCRIPTION	WEIGHT	MIN OPENING	MAX OPENING	FLEX (TRADE SIZE)	AWG SOL OR MC RANGE
RF-120A-WW	66978740	RF-120A-WW 1/2" – 3/4" Roto-Flex™ Cutter					
RF-120A-WW			1.25 lbs	0.75"	1.13"	1/2" - 3/4"	2/3 to 4/3



**RF-170-WW**

 **WE'VE GOT IT  
MADE IN AMERICA™**

The RF-170-WW cuts up to 1-1/2" flex or armored cable in seconds leaving a clean end. It makes cutting BX and Greenfield conduit easy and precise. The self-tightening blade system prevents you from damaging the cable. The RF-170-WW includes a blade storage cartridge in the knob with room for up to 6 spare blades. Proudly made in the USA.

- Cuts 1/2" to 1-1/2" flex
- Equipped with B-107 blade for aluminum
- Includes ergonomic handle with blade storage
- B-102 blade can be used with steel casing

### SPECIFICATIONS

MODEL #	STOCK #	DESCRIPTION	WEIGHT	MIN OPENING	MAX OPENING	FLEX (TRADE SIZE)	AWG SOL OR MC RANGE
RF-170-WW	66979040	RF-170-WW Giant Roto-Flex™ Cutter					
RF-170-WW			1.25 lbs	0.84"	1.82"	1/2" - 1-1/2"	

HAND TOOLS | WOUNDED WARRIOR PROJECT® LIMITED EDITION PRODUCTS



## ROTO-SPLIT® AND ROTO-FLEX™ STANDARD BLADE

**B-102**



The Southwire B-102 Standard Blade is the replacement blade for all Roto-Split® and Roto-Flex™ models. Proudly made in the USA.

- Sold in packs of 2
- Blade used to cut steel casing
- Replacement blade for RS-101A-WW, RS-101AC-WW, and RF-120A-WW

### SPECIFICATIONS

MODEL #	STOCK #	DESCRIPTION		
B-102	59814401	Replacement Blade for RS-101A-WW, RS-101AC-WW, RF-120A-WW		
MCBLADE	58282340	Replacement Blade for MCCUT-WW (1 Blade Per Pack)		
	HEIGHT	WIDTH	DEPTH	WEIGHT
B-102	1.26"	1.26"	0.025"	.006 lbs
MCBLADE	1.26"	1.26"	0.025"	.006 lbs

## OFFSET TEETH BLADE

**B-107**



The Southwire B-107 is a heavy-duty, universal blade that can be used on all Roto-Flex™ tools. It cuts through aluminum armor clad with minimal effort. It can also cut through steel armor on 1/2" and larger trade size flex. This is a great replacement blade for aluminum casing. Perfect for the electrician. Proudly made in the USA.

- Offset teeth to prevent clogging
- Used to cut aluminum casing
- For use with RF-170-WW
- Not for use with the RS-101A-WW, RS-101AC-WW or MCCUT-WW

### SPECIFICATIONS

MODEL #	STOCK #	DESCRIPTION		
B-107	59814901	Replacement Blade for RF-170-WW		
	HEIGHT	WIDTH	DEPTH	WEIGHT
B-107	1.26"	1.26"	0.025"	.006 lbs

# HAND TOOLS

## STRIP-ALL™ STRIPPER WITH KNIFE

SA-200SK

Strips plenum, communication, Romex™ cable, and category cables.



- Precision depth of cut adjustment
- Straight cut jacketed cables from 1/4" to 5/8"
- Ring cut cables up to 1/2"
- Includes cable stripper and folding utility knife
- B-202 for replacement blade



### SPECIFICATIONS

MODEL #	STOCK #	DESCRIPTION		
SA-200SK	59817340	Strip-All™ Striper with Knife		
B-202	59815401	Strip-All™ Replacement Blade		
HEIGHT	WIDTH	DEPTH	WEIGHT	
SA-200SK	9"	5.5"	1"	0.30 lbs
B-202	1.25"	1.25"	.03"	.030 lbs

## LARGE STRIP-ALL™ STRIPPER

SA-200SK

An increased capacity Strip-All™



- Precision depth of cut adjustment
- Make straight or ring cuts from 3/8" to 7/8"
- B-202 for replacement blade



### SPECIFICATIONS

MODEL #	STOCK #	DESCRIPTION		
SA-200L	59817101	Strip-All™ Striper, Large		
B-202	59815401	Strip-All™ Replacement Blade		
HEIGHT	WIDTH	DEPTH	WEIGHT	
SA-200L	9"	5.5"	1"	0.35 lbs
B-202	1.25"	1.25"	.03"	.030 lbs

# HAND TOOLS

## EDGEFORCE™ & STAINLESS STEEL KNIVES

### UTILQ0



### CDPK



### HBKN



### HBKND2



### UTILAR



### TBKND2-CAMO



### CSPKD2



### DPKD2



### BN01



Our knives feature a durable 8CR13MOV stainless-steel blade with a black-oxide finish and liner lock that keeps the blade secure. Our compact pocket knife is perfect for everyday carry and our hawk bill knife is the perfect pocket knife for pull cuts and splicing.

- Corrosion resistant
- Liner lock keeps blade secure
- Dual thumb studs for right or left hand opening
- Comfort grip for maximum hold and comfort
- Edgeforce™ D2 steel

## SPECIFICATIONS

MODEL #	STOCK #	DESCRIPTION
UTILQ0	65029040	Folding Utility Knife
CDPK	65029340	Compact Pocket Knife
HBKN	65029440	Hawkbill Folding Knife
HBKND2	65029640	EDGEFORCE™ Hawk Bill Knife
UTILAR	65029240	Auto Retracting Utility Knife
TBKND2-CAMO	65029840	EDGEFORCE™ Tanto Knife
CSPKD2	65029740	EDGEFORCE™ Sheepsfoot Knife
DPKD2	65029540	EDGEFORCE™ Drop Point Knife
BN01	58288440	Boot Knife

	HEIGHT	WIDTH	DEPTH	WEIGHT
UTILQ0	6.85"	1.61"	0.45"	0.30 lbs
CDPK	6.74"	1.05"	0.45"	0.10 lbs
HBKN	7.24"	1.57"	0.45"	0.25 lbs
HBKND2	7.24"	1.57"	0.45"	0.25 lbs
UTILAR	6.01"	0.45"	0.45"	0.30 lbs
TBKND2-CAMO	8.18"	1.5"	0.45"	0.25 lbs
CSPKD2	7.28"	1.05"	0.79"	0.23 lbs
DPKD2	7.09"	1.05"	0.79"	0.33 lbs
BN01	9.6"	3"	0.5"	0.4 lbs





# HAND TOOLS

## KEYSTONE TIP SCREWDRIVERS

**SD1/4K4US**



**SD5/16K6US**



Our USA keystone tip screwdrivers are constructed to handle the toughest jobs with ease. The cushion grip handles allow for maximum torque and comfort. These screwdrivers come with high-quality, precision-machined tips for an exact fit.

- 22% larger cushion grip handle provides ultimate comfort and maximum torque
- Corrosion-resistant shank
- Tether hole for tether or lanyard attachment
- No-hassle lifetime warranty



## SPECIFICATIONS

MODEL #	STOCK #	DESCRIPTION			
SD1/4K4US	65139240	1/4" Keystone Tip Screwdriver			
SD5/16K6US	65139340	5/16" Keystone Tip Screwdriver			
		HEIGHT	WIDTH	DEPTH	WEIGHT
SD1/4K4US		9"	1.35"	1.1"	0.30 lbs
SD5/16K6US		9"	1.35"	1.1"	0.45 lbs
		SHANK TYPE	SHANK LENGTH	TIP TYPE	
SD1/4K4US		Round	4"	Keystone	
SD5/16K6US		Round	6"	Keystone	



# HAND TOOLS

## CABINET TIP SCREWDRIVERS

**SD1/4C4US**



**SD1/4C6US**



**SD3/16C4US**



**SD3/16C6US**



**SD3/16C8US**



**WE'VE GOT IT  
MADE IN AMERICA™**

Our USA cabinet tip screwdrivers are constructed to handle the toughest jobs with ease. The cushion grip handles allow for maximum torque and comfort. These screwdrivers come with high quality—precision machined tips for an exact fit.

- 22% larger cushion grip handle provides ultimate comfort and maximum torque
- Corrosion-resistant shank
- Tether hole for tether or lanyard attachment
- No-hassle lifetime warranty

## SPECIFICATIONS

MODEL #	STOCK #	DESCRIPTION			
SD1/4C4US	65138740	1/4" Cabinet Tip Screwdriver			
SD1/4C6US	65138840	1/4" Cabinet Tip Screwdriver			
SD3/16C4US	65138940	3/16" Cabinet Tip Screwdriver			
SD3/16C6US	65139040	3/16" Cabinet Tip Screwdriver			
SD3/16C8US	65139140	3/16" Cabinet Tip Screwdriver			
		HEIGHT	WIDTH	DEPTH	WEIGHT
SD1/4C4US		8.5"	1.35"	1.35"	0.30 lbs
SD1/4C6US		10.5"	1.35"	1.35"	0.35 lbs
SD3/16C4US		8.5"	1.28"	1.35"	0.20 lbs
SD3/16C6US		10.5"	1.28"	1.35"	0.20 lbs
SD3/16C8US		12.5"	1.28"	1.35"	0.20 lbs
		SHANK TYPE	SHANK LENGTH	TIP TYPE	
SD1/4C4US		Round	4"	Cabinet	
SD1/4C6US		Round	6"	Cabinet	
SD3/16C4US		Round	4"	Cabinet	
SD3/16C6US		Round	6"	Cabinet	
SD3/16C8US		Round	8"	Cabinet	



**HAND TOOLS | DRIVERS**

# HAND TOOLS

## PHILLIPS TIP SCREWDRIVERS

**SD1P3US**



Our USA Phillip tip screwdrivers are constructed to handle the toughest jobs with ease. The cushion grip handles allow for maximum torque and comfort. These screwdrivers come with high quality, precision machined tips for an exact fit.

**SD2P4US**



- 22% larger cushion grip handle provides ultimate comfort and maximum torque
- Corrosion-resistant shank
- Tether hole for tether or lanyard attachment
- No-hassle lifetime warranty

**SD2P6US**



## SPECIFICATIONS

MODEL #	STOCK #	DESCRIPTION		
SD1P3US	65139440	#1 Phillips Head Screwdriver		
SD2P4US	65139540	#2 Phillips Head Screwdriver		
SD2P6US	65139640	#2 Phillips Head Screwdriver		
	HEIGHT	WIDTH	DEPTH	WEIGHT
SD1P3US	8.5"	1.28"	1.35"	0.25 lbs
SD2P4US	9"	1.35"	1.35"	0.30 lbs
SD2P6US	14"	1.35"	1.35"	0.05 lbs
	SHANK TYPE	SHANK LENGTH	TIP TYPE	
SD1P3US	Round	3"	#1 Phillips	
SD2P4US	Round	4"	#2 Phillips	
SD2P6US	Round	6"	#2 Phillips	

 **WE'VE GOT IT  
MADE IN AMERICA™**





## SQUARE TIP SCREWDRIVER

**SDQ2P4US**



The USA #2 square tip driver has a 22% larger cushion grip handle that provides ultimate comfort and maximum torque \*as compared to previous generations. The corrosion-resistant shank ensures durability to withstand rust, allowing for a longer life. This screwdriver comes with a high quality–precision machined tip for an exact fit. A tether hole is provided for tether/lanyard attachment for added convenience. Patent pending.

- 22% larger cushion grip handle provides ultimate comfort and maximum torque
- Corrosion-resistant shank
- Tether hole for tether or lanyard attachment
- No-hassle lifetime warranty

### SPECIFICATIONS

MODEL #	STOCK #	DESCRIPTION		
SDQ2P4US	58281640	#2 Square Tip Screwdriver		
	HEIGHT	WIDTH	DEPTH	WEIGHT
SDQ2P4US	8.5"	1.35"	1.35"	0.35 lbs
	SHANK TYPE		SHANK LENGTH	TIP TYPE
SDQ2P4US	Square		4"	Square

 **WE'VE GOT IT  
MADE IN AMERICA™**

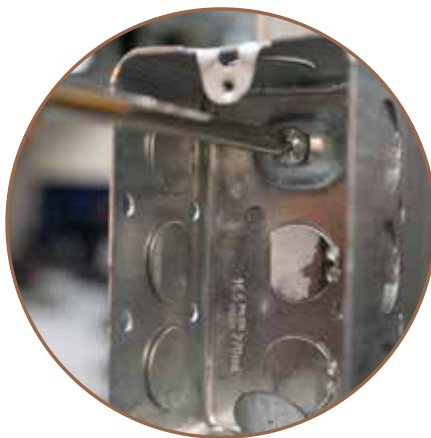

# HAND TOOLS

## 8-PIECE CUSHION GRIP SCREWDRIVER SET

SDSET8US

All-purpose assortment of frequently used screwdrivers.



- Comfortable cushion grip handle offers slip resistance and greater torque
- Precision tips for an exact fit
- Handles marked for easy identification
- Includes 8 pieces: 3/16" x 4", 3/16" x 6" and 1/4" x 4" slotted tip, 1/4" x 4" and 5/16" x 6" keystone tip, #1 x 3", #2 x 4", Phillips tip, and #2 x 4" square tipped screwdrivers

## 5-PIECE PRECISION SCREWDRIVER SET

SDPCSET5

All-purpose assortment of frequently used screwdrivers.



- Spinning cap for controlled one handed use
- Color coded rings for quick identification
- Heat treated precision ground tip for greater strength
- Patent pending cushion grip handle
- Corrosion resistant shank

## SPECIFICATIONS

MODEL #	STOCK #	DESCRIPTION	HEIGHT	WIDTH	DEPTH	WEIGHT	INCLUDES
SDPCSET5	65117040	5-Piece Precision Screwdriver Set	8.8"	4.7"	0.5"	0.25 lbs	1/16" Slotted x 2" shank, 1/8" Slotted x 3" shank, 1/8" Slotted x 4" shank, 3/32" Slotted x 3" shank, #0 Phillips x 3" shank

## 3-PIECE INSULATED SCREWDRIVER SET

### SDISET3



This screwdriver set comes with 3 insulated drivers that are tested to the ASTM F1505 international standard and provide 1000 volt insulated protection.

- 1000 volt insulated protection
- Tested to ASTM F1505 international standard
- Durable molded insulation offers visual wear indication
- Includes #2 Phillips x 4" shank, 1/4" slotted x 4" shank, and 3/16" slotted x 6" shank

## SPECIFICATIONS

MODEL #	STOCK #	DESCRIPTION	HEIGHT	WIDTH	DEPTH	WEIGHT	INCLUDES
SDSET8US	65139940	8-Piece Cushion Grip Screwdriver Set	8.5"	1.25"	1.25"	0.13 lbs	SD3/16C4, SD3/16C6, SD1/4K4HD, SD1/4C4, SD5/16K6HD, SD1P3, SD2P4HD, SDQ2P4
SDISET3	65172040	3 Piece Insulated Screwdriver Set	9"	1.35"	1.35"	0.13 lbs	#2 Phillips x 4" shank, 1/4" Slotted x 4" shank, 3/16" Slotted x 6" shank



# HAND TOOLS

## CONDUIT FITTING REAMING SCREWDRIVER

SDCFR



Removable conduit reaming screwdriver deburs thin wall conduit with speed and ease.

- Reams and smooths 1/2", 3/4", and 1" thin-wall conduit ends to protect wire and permit correct installation of fittings
- Reams inside and outside of conduit simultaneously
- Cushion grip handles for comfort and use
- Detachable head can also be used in a drill

### SPECIFICATIONS

MODEL #	STOCK #	DESCRIPTION	HEIGHT	WIDTH	DEPTH	WEIGHT
SDCFR	58283740	Conduit Fitting Reaming Screwdriver				
SDCFR			7.5"	1.25"	1.25"	0.59 lbs

## 6-IN-1 STUBBY MULT-BIT SCREWDRIVER

SDS6N1



The 6-in-1 multi-bit screwdriver features precision-machined, quick change bits.

- Includes 2 double sided screwdriver bits and 1 double sided nut driver
- Sizes include 5/16" & 1/2" hex, #1 & #2 Phillips, & 3/16" & 1/4" slotted tips
- Cushion grip handles for added comfort and improved torque
- Durable chrome-plated shaft is rust and corrosion resistant

### SPECIFICATIONS

MODEL #	STOCK #	DESCRIPTION	HEIGHT	WIDTH	DEPTH	WEIGHT
SDS6N1	58739740	6-in-1 Stubby Multi-Bit Screwdriver				
SDS6N1			3.50"	1.25"	1.25"	.20 lbs

# HAND TOOLS

## MULTI-BIT/ADJUSTABLE/ROTARY SCREWDRIVERS

### SD4N1P



### SD4N1P

- Precision screwdrivers make work in small spaces easier.
- Includes: 1/8" and 3/32" slotted, #0 and #00 phillips
- Spinning cap for controlled one handed use
- Patent pending cushion grip handle

### SD6N1P



### SD6N1P

- Comes with a precision bit allowing easier work in small spaces.
- #0 Phillips bit for precision work
- Chrome-plated finish for corrosion resistance
- Comfort grip handle provides extra comfort and maximum torque

### SD9N1



### SD9N1

- Convenient multi-tool screwdriver with nine tools in one.
- Comfortable cushioned grip allows firm grip and greater torque.
- Precision-machined tips reduce slipping
- Integral flanges provide a solid, twist-resistant blade anchor

### SD2N1AL



### SD2N1AL

- Allows for extending and shortening of the shank for work in different places
- Adjustable from 4" to 8"
- Pull collar down to extend shank and pull up to shorten
- Zinc-plated finish for corrosion resistance

## SPECIFICATIONS

MODEL #	STOCK #	DESCRIPTION		
SD4N1C	65028540	4-in-1 Magnetic Rotary Driver		
SD4N1P	65117240	4-in-1 Magnetic Screwdriver w/ Precision Bit		
SD6N1P	65028840	6-in-1 Screwdriver w/ Precision Bit		
SD9N1	58285640	9-in-1 Multi Tool Screwdriver		
SD2N1AL	65028640	2-in-1 Adjustable Length Screwdriver		
	HEIGHT	WIDTH	DEPTH	WEIGHT
SD4N1C	9.30"	1.28"	1.38"	0.75 lbs
SD4N1P	7.99"	0.67"	0.39"	0.16 lbs
SD6N1P	11.06"	1.28"	1.30"	0.60 lbs
SD9N1	11.02"	1.25"	1.57"	0.55 lbs
SD2N1AL	11.02"	1.2"	1.57"	0.75 lbs
TIP TYPE				
SD4N1C	#1 & #2 Phillips, 3/16" & 1/4" Slotted			
SD4N1P	1/8" and 3/32" slotted, #0 and #00 phillips			
SD6N1P	5/16" & 1/4" nut drivers, #1 & #0 Phillips, 1/4" & 3/16" Slotted			
SD9N1	1/4", 3/8", & 5/16" Hex, #1 & #2 Phillips, 1/4" & 3/16" Slotted, #1 & #2 Square			
SD2N1AL	#2 Phillips, 1/4" Slotted			

# HAND TOOLS

## 12-IN-1 MULTI-BIT SCREWDRIVER



The 12-in-1 multi-bit screwdriver has precision-machined, quick change bits.

- Precision-machined, quick change bits for driving hex, Phillips, slotted, and square head screws
- Handles 3/16", 1/4", 5/16" slotted; #1, #2, #3 Phillips; #1, #2, square recessed; and 1/4", 5/16", 3/8", 1/2" hex drive
- Cushion grip handle provides extra comfort and maximum torque
- Premium chrome-plated shaft is durable as well as rust and corrosion resistant
- Meets ANSI/ASME specifications

### SPECIFICATIONS

MODEL #	STOCK #	DESCRIPTION		
SD12N1	59723940	12-in-1 Multi-Bit Screwdriver		
HEIGHT	WIDTH	DEPTH	WEIGHT	
SD12N1	11.75"	3.25"	1.38"	0.85 lbs

## 9-IN-1 RATCHETING SCREWDRIVER



The 9-in-1 ratcheting multi-tool screwdriver allows for quick driving of screws and nuts.

- Precision-machined, quick change bits for driving hex, Phillips, slotted, and square head screws
- Handles 1/4", 3/8", 5/16" hex; #1 and #2 Phillips; 1/2" and 3/16" slotted; #1 and #2 square
- Cushion grip handle provides extra comfort and maximum torque
- Premium chrome-plated shaft is durable as well as rust and corrosion resistant
- Meets ANSI/ASME specifications

### SPECIFICATIONS

MODEL #	STOCK #	DESCRIPTION		
SDR9N1	59724040	9-in-1 Ratcheting Screwdriver		
HEIGHT	WIDTH	DEPTH	WEIGHT	
SDR9N1	11.75"	3.25"	1.50"	0.6 lbs

# HAND TOOLS

## NUT DRIVERS

**ND7/16-3US**



**ND1/2-3US**



**ND1/4-3US**



**ND3/8-3US**



**ND11/32-3US**



**ND3/16-3US**



**ND5/16-3US**



**WE'VE GOT IT  
MADE IN AMERICA™**

**ND6N1HD**



**NDS5N1**



This line of USA nut drivers includes a 7-piece set. The nut drivers have 22% larger cushion grip handles that provides ultimate comfort and maximum torque \*as compared to previous generations. The corrosion-resistant shank ensures durability to withstand damage, allowing for a longer life. A tether hole is provided for tether/lanyard attachment for added convenience. Patent pending.

- 22% larger cushion grip handle provides ultimate comfort and maximum torque
- Corrosion-resistant shank
- Tether hole for tether or lanyard attachment
- No-hassle lifetime warranty

## SPECIFICATIONS

MODEL #	STOCK #	DESCRIPTION					
ND7/16-3US	65138340	7/16" Nut Driver					
ND1/2-3US	65137840	1/2" Nut Driver					
ND1/4-3US	65137940	1/4" Nut Driver					
ND3/8-3US	65138140	3/8" Nut Driver					
ND11/32-3US	65138540	11/32" Nut Driver					
ND3/16-3US	65138440	3/16" Nut Driver					
ND5/16-3US	65138240	5/16" Nut Driver					
ND6N1HD	65028740	6-in-1 Heavy Duty Nut Driver					
NDS5N1	65116540	5-in-1 Stubby Nut Driver					
NDSET7US	65138640	7 Piece Nut Driver Set					
			HEIGHT	WIDTH	DEPTH	WEIGHT	SHANK LENGTH
ND7/16-3US			8"	1.35"	1.2"	0.35 lbs	3"
ND1/2-3US			8"	1.35"	1.2"	0.40 lbs	3"
ND1/4-3US			8"	1.28"	1.2"	0.25 lbs	3"
ND3/8-3US			8"	1.28"	1.2"	0.30 lbs	3"
ND11/32-3US			8"	1.28"	1.2"	0.30 lbs	3"
ND3/16-3US			8"	1.28"	1.2"	0.25 lbs	3"
ND5/16-3US			8"	1.28"	1.2"	0.30 lbs	3"
ND6N1HD			11.42"	1.25"	1.77"	1.00 lbs	-
NDS5N1			5.91"	1.77"	1.18"	0.28 lbs	-
NDSET7US			6"	1.40"	1.18"	2.00 lbs	-
			SHANK TYPE	SHANK LENGTH	TIP TYPE		
ND7/16-3US		Round		3"	7/16"		
ND1/2-3US		Round		3"	1/2"		
ND1/4-3US		Round		3"	1/4"		
ND3/8-3US		Round		3"	3/8"		
ND11/32-3US		Round		3"	11/32"		
ND3/16-3US		Round		3"	3/16"		
ND5/16-3US		Round		3"	5/16"		
ND6N1HD		-		-	3/16", 1/4", 5/16", 3/8", 7/16", 9/16"		
NDS5N1		-		-	3/16", 1/4", 5/16", 3/8", 1/2"		
NDSET7US		-		-	1/2", 1/4", 3/8", 5/16", 7/16", 3/16", and 11/32"		



HAND TOOLS | DRIVERS



# HAND TOOLS

## T-HANDLE HEX KEYS



Designed to efficiently tighten and loosen hex screws.

- T-handle design allows for greater torque application
- Hex key blade - long and short for flexible use
- Forged heavy-duty steel blade for durable usage
- Over molded grip for comfortable feel

### SPECIFICATIONS

MODEL #	STOCK #	DESCRIPTION			
THEX6-1/2	58287840	1/2" T-Handle Hex Key w/ 8" Shank			
HEIGHT	WIDTH	DEPTH	WEIGHT	SET LENGTH	
THEX6-1/2	9.75"	4.75"	1"	0.91 lbs	8"

THEX6-1/2

## FOLDING HEX KEY SETS



HEX-8

Convenient and reliable, these folding hex key sets will help you get the job done quickly and easily.

- Precision made hex keys reduce slipping and stripping
- Set easily stores in metal case to reduce lost keys and damage
- Strong durable body doubles as a handle

### SPECIFICATIONS

MODEL #	STOCK #	DESCRIPTION			
HEX-8	58287640	8-Piece Folding Hex Key Set			
HEX-5	58287540	5-Piece Folding Hex Key Set			
HEIGHT	WIDTH	DEPTH	WEIGHT	SET LENGTH	
HEX-5	5.25"	1.5"	0.75"	0.68 lbs	3/32", 7/64", 1/8", 9/64", 5/32", 3/16", 7/32", & 1/4"
HEX-8	5.25"	1.5"	0.75"	0.89 lbs	3/16", 7/32", 1/4", 5/16", & 3/8"



HEX-5

## CONDUIT BENDING LEVEL

MCBLEVEL



High visibility vials are easy to read and set for measurements at 0°, 30°, 45°, and 90°.

- Set screw secures level to conduit
- Four powerful magnets for hands free operation
- Easy-to-read, high impact, acrylic bubble vials
- V-grooved edge helps hold the level in place on pipe or conduit
- Lightweight and durable aluminum construction

### SPECIFICATIONS

MODEL #	STOCK #	DESCRIPTION			
MCBLEVEL	58281640	6" Conduit Bending Level			
HEIGHT	WIDTH	DEPTH	WEIGHT	SET INCLUDES	
MCBLEVEL	6.31"	1.88"	0.63"	0.31 lbs	Magnets, thumb screw for attaching to conduit

# HAND TOOLS

## ELECTRICIAN'S SHOULDER POUCH

### BAGESP



Convenient shoulder bag provides a lightweight, durable tool carrier that can be hand-carried, slung over your shoulder, or attached to a belt. Features 16 storage pockets.

- Multiple carrying options: shoulder strap, padded handle, belt loop tunnel
- Constructed from 2400D ballistic weave for durability
- 16 tool storage pockets

## SPECIFICATIONS

MODEL #	STOCK #	DESCRIPTION		
BAGESP	58738740	Electrician's Shoulder Pouch		
HEIGHT	WIDTH	DEPTH	INTERNAL CAPACITY	
BAGESP	12"	8.5"	6.5"	247 Cubic Inches/4 Liters

## TOOL BACKPACK

### PROBAGBP



Our tool backpack allows you to comfortably carry your tools on your back or by hand. Easy opening zippers allow access to the numerous tool storage compartments. Enclosed pouches are located on both external and internal surfaces to provide additional tool storage security.

- Constructed from 2400D ballistic weave for durability
- 58 storage pockets, zippered pouches, and tool loops
- Non-tipping rubber base is wear and water resistant
- Fully molded base allows bag to stand freely

## SPECIFICATIONS

MODEL #	STOCK #	DESCRIPTION		
PROBAGBP	67599040	Tool Backpack		
HEIGHT	WIDTH	DEPTH	INTERNAL CAPACITY	
PROBAGBP	18.7"	13.78"	7.87"	1, 235 Cubic Inches

## 5-POCKET LEATHER TOOL POUCH

### POUCH4



The 5-pocket leather tool pouch with electrical tape chain is designed for easy storage and tool access.

- Saddle leather is resistant to fading and staining
- Washer rivets for extra strength
- Fits belts up to 3" wide

### SPECIFICATIONS

MODEL #	STOCK #	DESCRIPTION		
POUCH4	58283140	5 Pocket Tool Pouch*		
	HEIGHT	WIDTH	DEPTH	MATERIAL
POUCH4	9.25"	7"	3"	Leather

\*tools not included.

## ELECTRICIAN'S WORK GLOVES

### GLOVE1L



High dexterity electrician's gloves with anti-slip fingertips.

- Anti-slip finger tips for secure holding of wire and tools
- Padded palm for protection and secure grip
- Wrapped index finger for durability
- Breathable spandex back for comfortable fit and feel
- Touchscreen compatible index finger and thumb

### SPECIFICATIONS

MODEL #	STOCK #	DESCRIPTION
GLOVE1L	58739040	Electrician's Work Gloves - Large
	PRIMARY MATERIAL	SECONDARY MATERIAL
GLOVE1L	Breathable Spandex	Synthetic Leather



# HAND TOOLS

## CANVAS ZIPPER BAG

### BAG12



Our canvas zipper bag is a very convenient storage place for pliers, wrenches, and other tools that you use daily.

### BAG12

- Durable, heavy-duty cotton canvas bag
- Sturdy plastic resin zipper

### BAG4P

- 4-Pack of durable polyester bags with sturdy resin zipper
- Perfect for storing Pliers, screwdrivers, staples or electrical connectors.

### BAG4P



## SPECIFICATIONS

MODEL #	STOCK #	DESCRIPTION		
BAG12	58282840	12" Canvas Zipper Bag		
BAG4P	59724140	Polyester Zippered Bag 4-Pack		
	HEIGHT	WIDTH	DEPTH	WEIGHT
BAG12	7"	12"	0.25"	0.13 lbs
BAG4P	7"	11.5"	1.00"	0.35 lbs

# HAND TOOLS

## ELECTRICAL MAINTENANCE KIT



With Southwire's Electrical Maintenance Kit, you will be prepared for any bumps in the road. From loose connections to a dark campsite, our EM-KIT has you covered to perform basic electrical testing in addition to providing tools for maintenance and quick repairs.



### MULTIMETER

- Measure battery & outlet voltage, check fuses, test heating element

### 7-IN-1 MULTI-TOOL PLIER

- Perfect for wire cutting, stripping, gripping in addition to crimping new terminals

### MULTI-BIT SCREWDRIVER

- Slotted: 3/16", 1/4"
- Phillips: #1, #2
- Square Recessed: #1, #2
- Hex Driver: 1/4", 5/16", 3/8"



### LED HEADLAMP

- Illuminate work environment hands-free
- Adjustable strap

### BUSS BLADE FUSES

- 10A, 15A, 20A, & 30A rated fuses

### COMPACT POCKET KNIFE

- Folding blade with liner lock belt clip

### ELECTRICAL TAPE

- 30 foot length

### CABLE TIES

- 14 inch length



## SPECIFICATIONS

MODEL #	STOCK #	DESCRIPTION	HEIGHT	WIDTH	DEPTH	WEIGHT
EM-KIT	66983440	Electrical Maintenance Kit				
EM-KIT			17"	11"	3"	12 lbs.

# HAND TOOLS

## APPRENTICE KITS

Southwire is excited to introduce our new apprentice kits! The tools in these kits are built to withstand jobsite wear and tear. Constructed with Fire Rivet™ technology, our pliers are designed to provide clean cuts with no wobble while our wire stripper is made with stainless steel cutting blades for fast and clean wire stripping. Our screwdrivers and nut drivers feature a comfortable hex shaped handle for maximum torque and a tether hole for lanyard attachment. The compact voltage and GFCI tester measures AC and DC voltage, tests GFCI outlets and circuits, and has an easy to read LED display. The non-contact voltage detector includes a built-in flashlight and pocket clip for easy storage. Both kits include a tool bag for storing these essential tools!

### 14PC APPRENTICE KIT

- SCP9TPC: 9" Side Cutting Pliers
- LNP8SD: 8" Long Nose Pliers
- DCPA8D: 8" Diagonal Cutting Pliers
- S1018STR: Wire Stripper
- SD1/4C6US: 1/4" Cabinet Tip Screwdriver
- SD2P4US: #2 Phillip's Head Screwdriver
- SD3/16C6US: 3/16" Cabinet Tip Screwdriver
- SD1P3US: #1 Phillip's Head Screwdriver
- SDQ2P4US: #2 Square Tip Screwdriver
- ND5/16-3US: 5/16" Nut Driver
- ND1/4-3US: 1/4" Nut Driver
- 41151S: Voltage and GFCI Tester
- 40136N: Non-Contact Voltage Detector
- BAGESP: Electrician's Shoulder Pouch

### 10PC APPRENTICE KIT

- SCP9TPC: 9" Side Cutting Pliers
- LNP8SD: 8" Long Nose Pliers
- DCPA8D: 8" Diagonal Cutting Pliers
- S1018STR: Wire Stripper
- SD1/4C6US: 1/4" Cabinet Tip Screwdriver
- SD2P4US: #2 Phillip's Head Screwdriver
- SD3/16C6US: 3/16" Cabinet Tip Screwdriver
- SD1P3US: #1 Phillip's Head Screwdriver
- 40136N: Non-Contact Voltage Detector
- BAGESP: Electrician's Shoulder Pouch

### 14PKIT



### 10PKIT



## SPECIFICATIONS

MODEL #	STOCK #	DESCRIPTION	HEIGHT	WIDTH	DEPTH	WEIGHT
14PKIT	65187640	14PKIT, 14 Piece Tool Kit	17.38"	11.5"	7.38"	8.30 lbs.
10PKIT	65187840	10PKIT, 10 Piece Tool Kit	17.38"	11.5"	7.38"	6.75 lbs.

# HAND TOOLS

## USA TOOL KIT



**WE'VE GOT IT  
MADE IN AMERICA™**

Southwire is proud to introduce our new made in the USA apprentice kit! The tools in this kit are built to withstand jobsite wear and tear. Constructed with Hot Rivet technology, our pliers are designed to provide clean cuts with no wobble while our wire stripper is made from durable heat-treated steel for longer life. Our screwdrivers feature a comfortable hex shaped handle for maximum torque and a tether hole for lanyard attachment. Proudly supporting the Wounded Warrior Project®.

### 6PCUSAKIT-WW

- SCP9TPCD-WW: 9" Side Cutting Pliers
- DCPA8D-WW: 8" Diagonal Cutting Pliers
- TCC9D-WW: 9" Terminal Crimper Cutter
- S1018SOL-WW: Wire Stripper
- SD1/4C6US: 1/4" Cabinet Tip Screwdriver
- SD2P4US: #2 Phillip's Head Screwdriver

## SPECIFICATIONS

MODEL #	STOCK #	DESCRIPTION		
6PUSAKIT-WW	67035140	USA Tool Kit, 6 Piece		
	HEIGHT	WIDTH	DEPTH	WEIGHT
6PUSAKIT-WW	14.00"	10.38"	2.125"	5 lbs.



**HAND TOOLS** | **WOUNDED WARRIOR PROJECT®**  
LIMITED EDITION PRODUCTS



# HAND TOOLS

## 4-PIECE ELECTRICIAN'S TOOL KIT

EKIT-4



Complete with 10-18 AWG wire stripper, 9-in-1 multi-bit screwdriver, high leverage side cutting pliers, and nylon carrying pouch.

### 10-18 AWG WIRE STRIPPER - MODEL # S1018STR

- Strips and cuts 10-18 AWG solid and 12-20 AWG stranded wire
- Stainless steel construction is durable and corrosion resistant
- Double-dipped grip provides comfortable fit
- Specially designed stainless steel cutting blades provide fast and clean wire stripping
- Serrated nose grasps the cable for easy twisting and pulling
- Spring loaded for self-opening action
- Not intended for cutting bolts or steel cable

### HIGH LEVERAGE SIDE CUTTING PLIERS - MODEL # SCP9

- Induction hardened cutting blades ensure efficient and lasting cutting surfaces for hard and soft wire
- File teeth on jaws help remove burrs in conduit
- Cuts ACSR, screws, nails, and most hardened wire
- Curved handle and ergonomic molded grip for comfortable use
- Drop forged CRV steel for durability

### 9-IN-1 MULTI-BIT SCREWDRIVER - MODEL # SD9N1

- Includes 6 bits and 3 nut drivers for multi-purpose use
- Cushion grip handle for comfortable use and maximum torque application

## SPECIFICATIONS

MODEL #	STOCK #	DESCRIPTION	HEIGHT	WIDTH	DEPTH	WEIGHT	INCLUDES
EKIT-4	59158740	4-Piece Electrician's Tool Kit					
EKIT-4	9.75"	4.25"	2.25"	0.35 lbs	S1018STR, SCP9, and SD9N1		

## CABLE SPLICERS KIT

CSK5



Cable splicers kit is ideal for prepping category cable installation.

- Lock holds blades closed for storage
- Serrated lower blades grip wire for non-slip cutting action
- Includes marking pen
- Includes leather carrying pouch
- Includes boot knife for sheathing and removing cable jackets

### SPECIFICATIONS

MODEL #	STOCK #	DESCRIPTION		
CSK5	59724240	Cable Splicers Kit		
	HEIGHT	WIDTH	DEPTH	WEIGHT
CSK5	8.25"	3.8"	2.2"	0.8 lb.



## BASIC ELECTRICIAN'S KIT

BEKIT-3



The perfect start to your electrical work tool box. These three tools are exactly what you need to get started on any simple electrical task.

- The S1018STR stainless steel wire stripper is rust resistant
- The SD9N1 Multi-Bit Screwdriver includes #1 & #2 Phillips tips, 1/4", 5/16", & 3/8" hex drivers, 3/16" & 1/4" slotted tips, and #1 & #2 square tips
- The 40116N NCV has a detection range of 100-600V AC

### SPECIFICATIONS

MODEL #	STOCK #	DESCRIPTION		
BEKIT-3	63136840	Basic Electrician's Kit		
	HEIGHT	WIDTH	DEPTH	WEIGHT
BEKIT-3	10.25"	7.88"	0.75"	2 lbs

# FISHING & BENDING

---

Introducing our unique line of fish tapes, featuring a spiral extruded polymer material that reduces the amount of effort required to push or pull the fish tape through EMT and PVC conduit. Unlike fiberglass, the SIMpull™ fish tapes are kink resistant, ensuring maximum efficiency\*.

*\*As compared to Southwire steel and fiberglass fish tapes.*

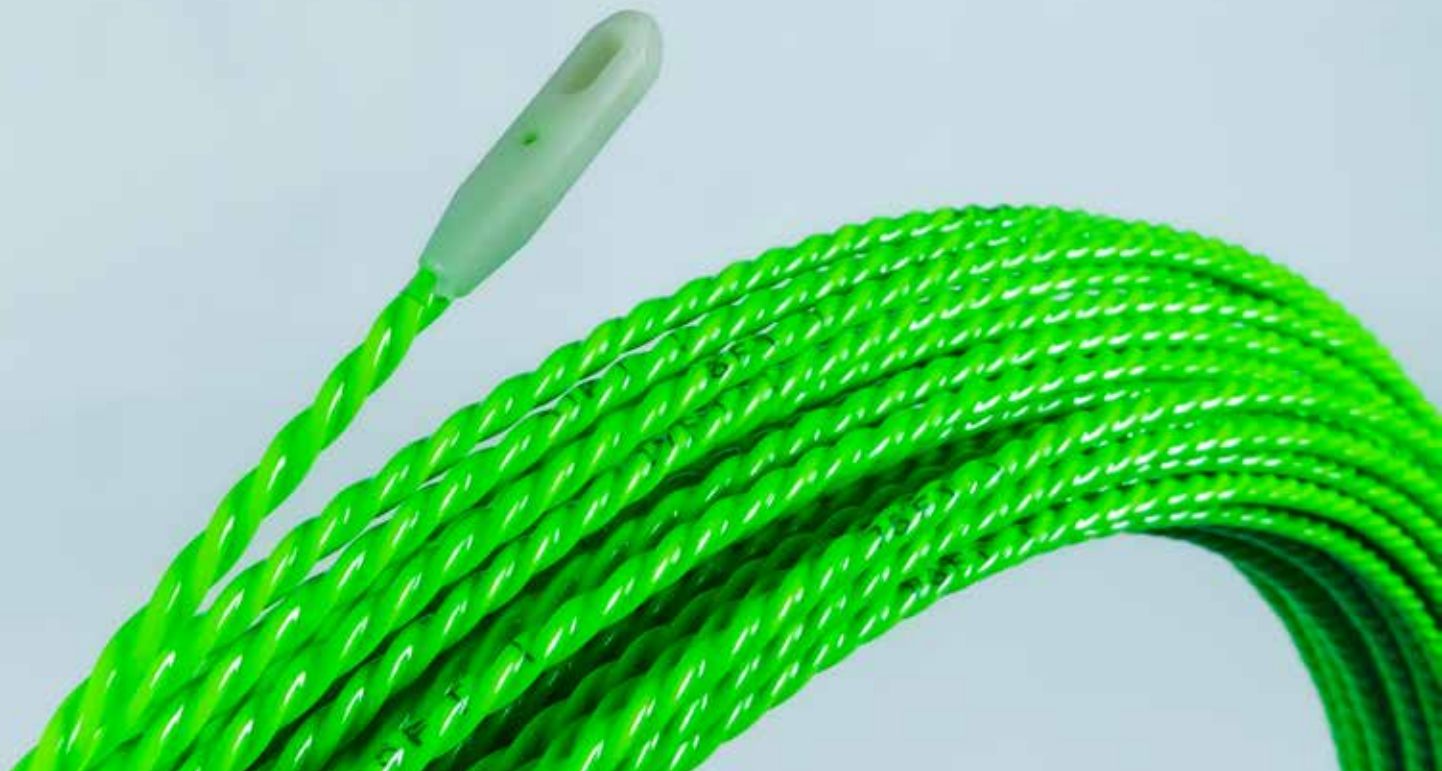

# FISHING & BENDING

## SIMpull™ NON-CONDUCTIVE TIP FISH TAPE



**FTSP55-125NCT**

The SIMpull™ non-conductive fish tape is our best option to safely install new wire in conduit with existing wire. The spiral extruded polymer tape reduces the amount of effort required to push or pull the tape through EMT or PVC conduit.

- Tapered tip – reduces the chance of snagging on wire & conduit
- Improve push - 4.5mm Tape for conduit upwards of 2" and 5.5mm Tape for 3"
- Advanced tape guide & housing – improved internal mechanics to greatly increase efficiency of payout & reel-in
- Non-conductive – allows for safe installation over existing wires
- Durability certified – drop rating of 15 feet
- Laser etched foot markings for 5.5mm tape help measure conduit runs
- Versatile handle positioning



NON-CONDUCTIVE LEADER



DOES NOT BREAK WHEN FOLDED



GLOW IN THE DARK



FASTER INSTALL TIME



## SPECIFICATIONS

MODEL #	STOCK #	DESCRIPTION			
FTSP55-125NCT	67015540	SIMpull™ Non-Conductive Tip Fish Tape 5.5mm 125' Foot Markings			
FTSP45-125NCT	63163740	SIMpull™ Non-Conductive Tip Fish Tape 4.5mm 125'			
FTSP45-75NCT	63029840	SIMpull™ Non-Conductive Tip Fish Tape 4.5mm 75'			
	HEIGHT	WIDTH	DEPTH	DIAMETER	WEIGHT
FTSP55-125NCT	16"	12"	2"	5.5mm	2.5 lbs
FTSP45-125NCT	16"	12"	2"	4.5mm	2.5 lbs
FTSP45-75NCT	16"	12"	1.5"	4.5mm	2.0 lbs



FISHING & BENDING | SIMpull™ FISH TAPE



# FISHING & BENDING

## SIMpull™ FLEXIBLE METAL LEADER FISH TAPE



**FTSP55-125FML**

The SIMpull™ flexible metal leader tape excels at gliding through conduit with multiple bends. The spiral extruded polymer tape reduces the amount of effort required to push or pull the tape through EMT or PVC conduit.

- Swiveling flexible leader – easily glides through conduit bends and around existing wire
- Improve push - 4.5mm Tape for conduit upwards of 2" and 5.5mm Tape for 3"
- Advanced tape guide & housing – improved internal mechanics to greatly increase efficiency of payout & reel-in
- Durability certified – drop rated of 15 feet
- Laser etched foot markings for 5.5mm tape help measure conduit runs
- Versatile handle positioning



SWIVELING  
LEADER



DOES NOT BREAK  
WHEN FOLDED



FASTER INSTALL  
TIME

## SPECIFICATIONS

MODEL #	STOCK #	DESCRIPTION			
FTSP55-125FML	67015240	SIMpull™ Flexible Metal Leader Fish Tape 5.5mm 125' Foot Markings			
FTSP45-125FML	59896940	SIMpull™ Flexible Metal Leader Fish Tape 4.5mm 125'			
FTSP45-75FML	59897040	SIMpull™ Flexible Metal Leader Fish Tape 4.5mm 75'			
	HEIGHT	WIDTH	DEPTH	DIAMETER	WEIGHT
FTSP55-125FML	16"	12"	2"	5.5mm	2.5 lbs
FTSP45-125FML	16"	12"	2"	4.5mm	2.5 lbs
FTSP45-75FML	16"	12"	1.5"	4.5mm	2.0 lbs



# FISHING & BENDING

## SIMpull™ FISH TAPE TUBE

### FTSP45-240FMLT



The SIMpull™ tube is designed for long runs over 125'. This model has the added benefit of both leader types within the same unit. The spiral extruded polymer tape reduces the amount of effort required to push or pull the tape through EMT or PVC.

- Includes both a 360° swiveling flexible metal leader and a non-conductive glow in the dark leader, one on either end
- Swiveling flexible leader – easily glides through conduit bends and around existing wire
- Improve push - 4.5mm Tape for conduit upwards of 2" and 5.5mm Tape for 3"
- Laser etched foot markings for 5.5mm tape help measure conduit runs

## SPECIFICATIONS

MODEL #	STOCK #	DESCRIPTION			
FTSP55-240FMLT	67015840	SIMpull™ Tube Fish Tape with both FML & NCT Tips 5.5mm, 240'			
FTSP45-240FMLT	63164740	SIMpull™ Tube Fish Tape with both FML & NCT Tips 4.5mm, 240'			
	HEIGHT	WIDTH	DEPTH	DIAMETER	WEIGHT
FTSP55-240FMLT	24"	24"	4"	5.5mm	4.3 lbs
FTSP45-240FMLT	24"	24"	4"	4.5mm	4.3 lbs

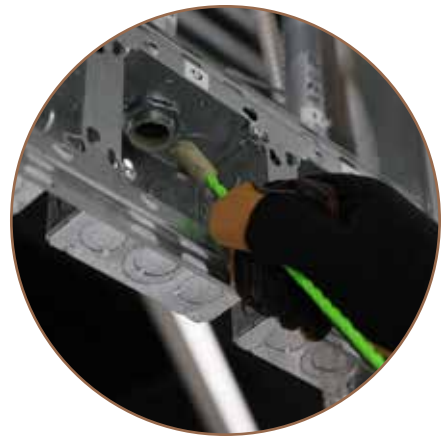
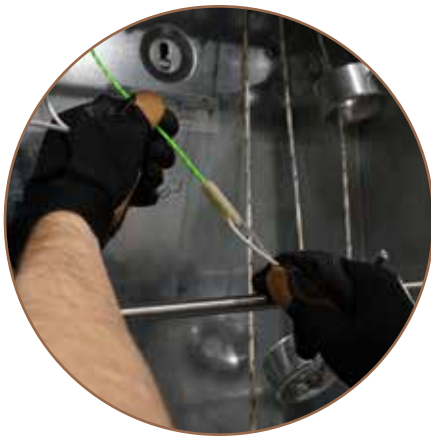

# FISHING & BENDING

## STAINLESS STEEL FISH TAPE



**FTS1/8-125SS**

Stainless steel tape incorporates the same benefits of steel but with added life.

- Stainless steel – highly resistant to rust & corrosion. Increasing the product's lifespan.
- Advanced tape guide & housing – improved internal mechanics to greatly increase efficiency of payout & reel-in.
- Durability certified – drop rating of 15 Feet
- Laser etched foot markings
- Versatile handle positioning



### SPECIFICATIONS

MODEL #	STOCK #	DESCRIPTION			
FTS1/8-125SS	67014640	125' Stainless Steel Fish Tape 1/8"			
FTS1/8-240SS	67014940	240' Stainless Steel Fish Tape 1/8"			
	LENGTH	WIDTH	DEPTH	WEIGHT	TAPE WIDTH
FTS1/8-125SS	17"	12"	2"	4.5 lbs	1/8"
FTS1/8-240SS	17"	12"	2"	7.3 lbs	1/8"

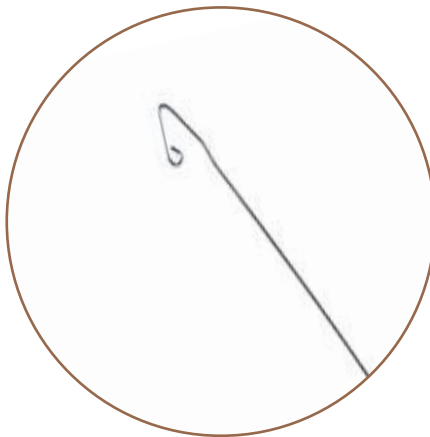

# FISHING & BENDING

## STEEL FISH TAPE



Southwire's steel fish tape reaches easily above ceilings, under carpets, and through walls to install wire. The fish tape is available in multiple lengths.

- Easy pulls – specially treated steel fish tape for longer life and easier pulling.
- Better accuracy – laser etched footage markings to help identify length of pull
- Rugged design – high impact, durable case for long lasting performance and use.
- Laser etched foot markings
- Versatile handle positioning



## SPECIFICATIONS

MODEL #	STOCK #	DESCRIPTION			
FTS1/8-240	58279840	1/8" Fish Tape Steel 240'			
FTS1/8-125	58279940	1/8" Fish Tape Steel 125'			
FTS1/8-25	58280240	1/8" Fish Tape Steel 25'			
HEIGHT	WIDTH	DEPTH	WEIGHT	TAPE WIDTH	
FTS1/8-240	17"	12"	2"	7.3 lbs	1/8"
FTS1/8-125	17"	12"	2"	4.5 lbs	1/8"
FTS1/8-25	8.5"	7"	1"	1.0 lbs	1/8"



# FISHING & BENDING

## FISH TAPE LEADER



FTFL13

Flexible leader guides steel tapes through conduit and helps reduce the challenge of pulling and pushing.

- Flexible 13" leader easily attaches to 1/8" steel fish tapes
- Assists in guiding steel fish tapes through conduit turns and bends

### SPECIFICATIONS

MODEL #	STOCK #	DESCRIPTION				
FTFL13	58280640	Fish Tape Leader 13' for Steel Fish Tapes				
LENGTH	WIDTH	DEPTH	WEIGHT	TAPE WIDTH	EYELET CAPACITY	
FTFL13	14.25"	0.38"	0.25"	2 oz.	3/16	5 x 12 AWG Upstripped, 7 x 10 AWG Bare

## GLOW-IN-THE-DARK FISH STICK



Make fishing through walls or over ceilings easier with our Glow-in-the-Dark Fish Sticks.

- Luminescent fiberglass rods glow in the dark and recharge with most available light sources
- 3/16" flexible rods resist splintering and cracking
- Individual sections easily screw together to form single rod
- Includes bullet nose with eyelet and hook attachments

### SPECIFICATIONS

MODEL #	STOCK #	DESCRIPTION			
FS15	58279340	15' Glow-in-the-Dark Fish Stick (Includes Bullet Nose with Eyelet & Hook Attachments)			
FS12	58279440	12' Glow-in-the-Dark Fish Stick (Includes Bullet Nose with Eyelet & Hook Attachments)			
FS8	58279540	8' Glow-in-the-Dark Fish Stick (Includes Bullet Nose with Eyelet & Hook Attachments)			
ASSEMBLED LENGTH	WIDTH	DEPTH	WEIGHT	STICK LENGTH	
FS15	180"	0.19"	0.19"	13.3 oz.	3x5' Pieces
FS12	144"	0.19"	0.19"	13.9 oz.	3x4' Pieces
FS8	96"	0.19"	0.19"	8 oz.	4x2' Pieces

# FISHING & BENDING

## CONDUIT BENDERS



Reliably and repeatedly perform common bends, such as stub-ups, offsets, back-to-back, and saddle bends. Available in 1", 3/4", and 1/2" sizes.

- Ductile iron and aluminum heads are built to provide lasting durability
- Swaged steel handle permits insertion of conduit to correct overbends
- Raised and highly visible bender markings are cast on both sides of the bender head
- Large serrated step provides greater control and helps prevent slipping when applying force

## SPECIFICATIONS

MODEL #	STOCK #	DESCRIPTION			
MCB1	58281440	1" EMT Conduit Bender with Handle (Ductile Iron Head)			
MCB3/4	58281240	3/4" EMT Conduit Bender with Handle (Aluminum Head)			
MCB1/2	58281340	1/2" EMT Conduit Bender with Handle (Aluminum Head)			
	HEIGHT	WIDTH	DEPTH	WEIGHT	CONDUIT SIZE
MCB1	1.75"	12"	45"	13 lbs	1" EMT 3/4" Rigid
MCB3/4	1.25"	9"	39"	9 lbs	3/4" EMT 1/2" Rigid
MCB1/2	1.25"	8"	39"	7 lbs	1/2" EMT

# TEST & MEASUREMENT

When there's no room for error, depend on our reliable test and measurement tools to get the job done. Backed by a five year warranty, these tools withstand the elements and provide accurate, versatile, and professional results that every electrician can count on.



# METER SELECTION GUIDE

## CAT IV MULTIMETERS

**5 YEAR WARRANTY**



Family	TechnicianPRO™			Compact Series	
Model #	14090T	14070T	14060S	16020N	16030A
Safety Rating	CAT IV 600V, CAT III 1000V	CAT IV 600V, CAT III 1000V	CAT IV 600V, CAT III 1000V	CAT IV 600V	CAT IV 600V
AC/DC Voltage	1000V	1000V	1000V	600V	600V
AC/DC Current	10A	10A	10A	200mA	
True RMS	X	X			X
Low Z	X	X			
Bluetooth®	X				
Backlighting Display=D Controls=C	C,D	C,D	C,D	D	D
Waterproof IP67	X	X	X		X
Work Light	X	X	X	X	
MAX/MIN/AVG	MAX/MIN/AVG	MAX/MIN/AVG	MAX/MIN		
Temperature	X	X	X		
Built-In NCV*				100V - 600V	100V - 600V
Resistance	60MΩ	60MΩ	60MΩ	40MΩ	40MΩ
Diode Test	X	X	X	X	
Capacitance	6000μF	6000μF	4000μF	100μF	
Frequency	10kHz	10kHz	10kHz	10kHz	
Duty Cycle	X	X	X	X	
Peak Hold	X	X			
Drop Protection	2m	2m	2m	2m	2m

\*All Southwire multimeters, clamp meters, and NCV's are UL listed





# METER SELECTION GUIDE

## CAT III MULTIMETERS

**5 YEAR WARRANTY**



Family	ResidentialPRO™			General Purpose	
Model #	13090T	13070T	13050S	10041N	10031S
Safety Rating	CAT III 600V	CAT III 600V	CAT III 600V	CAT III 600V	CAT III 300V, CAT II 600V
AC/DC Voltage	600V	600V	600V	600V	600V
AC/DC Current	10A	10A	10A	10A	10A (DC Only)
True RMS	X	X			
Low Z	X	X			
Bluetooth®	X				
Backlighting Display=D Controls=C	D	D	D	D	
Waterproof IP67	X	X	X		
Work Light	X	X	X		
MAX/MIN/AVG	MAX/MIN	MAX/MIN	MAX/MIN		
Temperature	X	X	X	X	
Built-In NCV*				50V to 600V	
Resistance	40MΩ	40MΩ	40MΩ	40MΩ	2.0MΩ
Diode Test	X	X	X	X	
Capacitance	1000μF	4000μF	4000μF	100μF	
Frequency	10MHz	10MHz	10MHz	10MHz	
Duty Cycle	X	X	X	X	
Drop Protection	2m	2m	2m	2m	2m

\*All Southwire multimeters, clamp meters, and NCV's are UL listed



# METER SELECTION GUIDE

## CAT III CLAMP METERS

**5 YEAR WARRANTY**



Model #	21550T	21530T	21510N
Safety Rating	CAT III 600V	CAT III 600V	CAT III 600V
AC/DC Voltage	600V	600V	600V
AC Current	400A	400A	400A
DC Current	400A		
True RMS	X	X	
Worklight	X	X	X
Backlit Display	X	X	X
Drop Protection	2m	2m	2m
Display Count	4,000	4,000	4,000
Bar Graph			
MAX/MIN/AVG	MAX/MIN	MAX/MIN	
Temperature	X	X	X
Built-in NCV*	50-600V AC	50-600V AC	50-600V AC
Resistance	40MΩ	40MΩ	40MΩ
Continuity	X	X	X
Diode Test	X	X	X
Capacitance	1000μF	1000μF	1000μF
Frequency			
Duty Cycle			
Auto Power Off	X	X	X

\*All Southwire multimeters, clamp meters, and NCV's are UL listed 

# METER SELECTION GUIDE

## CAT IV CLAMP METERS

**5 YEAR WARRANTY**



Model #	23090T	23070T	23030T
Safety Rating	CAT IV 600V, CAT III 1000V	CAT IV 600V, CAT III 1000V	CAT IV 600V, CAT III 1000V
AC/DC Voltage	1000V	1000V	1000V
AC Current	1000A	1000A	1000A
DC Current	1000A	1000A	
True RMS	X	X	X
Bluetooth®	X		
Worklight	X	X	X
Backlit Display	X	X	X
Drop Protection	1.5m	1.5m	1.5m
Display Count	50,000	6,000	6,000
Bar Graph	X	X	X
MAX/MIN/AVG	MAX/MIN	MAX/MIN	MAX/MIN
Temperature	X	X	X
Built-in NCV*	110-1000V AC	100-1000V AC	100-1000V AC
Resistance	50MΩ	60MΩ	60MΩ
Continuity	X	X	X
Diode Test	X	X	X
Capacitance	5mF	6000μF	6000μF
Frequency	10MHz	10MHz	10MHz
Duty Cycle	X	X	X
Inrush	X		

\*All Southwire multimeters, clamp meters, and NCV's are UL listed 

# METER SELECTION GUIDE

## CAT IV NON-CONTACT VOLTAGE DETECTORS

**5 YEAR WARRANTY**



Model #	40150N	40136N	40126N	40116N
Voltage Detection Range(s)	12-1000	50-600	24-600	100-600
	100-1000		100-600	
Safety Rating	CAT IV 1000	CAT IV 600	CAT IV 600	CAT IV 600
Forward Worklight	Yes	No	No	No
Rear Facing Light	Yes	Yes	Yes	Yes
On/Off Button	Yes	Yes	Yes	Yes
Low Batt Self Test	Yes	Yes	Yes	Yes
Auto Power Off	Yes	Yes	Yes	Yes
Silent Mode	Yes	Yes	No	No
Variable Flash & Beep Rate	Yes	Yes		
Ingress Protection	IP67			
Drop Protection	2m	1.5m	1.5m	1.5m

\*All Southwire multimeters, clamp meters, and NCV's are UL listed 



# MAPP™ MOBILE APP

## MAPP™ MOBILE APP



TEST & MEASUREMENT | MAPP™



Download on the  
**App Store**



GET IT ON  
**Google Play**

**Mobile app for connecting to Southwire Bluetooth® enabled meters.**

- View readings from a safe distance right from your mobile phone
- Set up recording sessions
- Add photos and notes to create a detailed report
- Pop-up menu to modify meter settings remotely
- Communicate critical equipment issues by email

The Bluetooth word mark and logos are registered trademarks of Bluetooth® SIG, Inc. and any use of such marks by Southwire Company, LLC is under license. Apply & the Apple logo are trademarks of Apple, INC, registered in the U.S. and other countries. App Store is a service mark of Apple, Inc.

# MAPP™ MOBILE APP



VIEW READINGS AND SET UP RECORDING SESSIONS FROM MOBILE DEVICE



JOB VALIDATION: ADD PHOTOS, NOTES AND GPS LOCATION

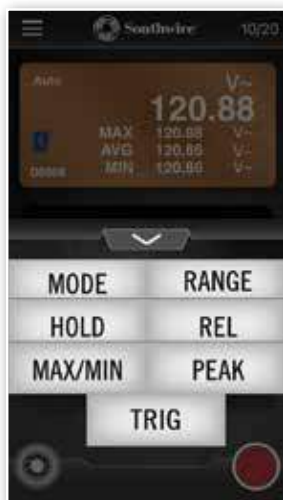

POP-UP MENU MODIFIES METER SETTINGS REMOTELY



E-MAIL REPORTS TO MAINTENANCE TEAM ON CRITICAL EQUIPMENT ISSUES

# TEST & MEASUREMENT

## TECHNICIANPRO™ BLUETOOTH® CAT IV MULTIMETER

14090T



This Bluetooth® enabled multimeter in combination with Southwire's MApp™ mobile app allows you to view, record, and share readings on your smartphone. It is designed for demanding environments. Features include a CAT IV safety rating, a rugged IP67 waterproof and dust tight housing, TrueRMS and Low-Z readings, backlit controls, and a powerful built-in work light.

- Features automatic power-off
- Bluetooth® interface for viewing, recording, and sharing using Southwire's MApp™ mobile app
- Lighted controls and backlit display allow use in dimly lit areas
- TrueRMS readings provide higher accuracy on AC circuits
- Low-Z function eliminates false readings from "ghost" voltage
- Includes magnetic hanging strap for hands-free operation
- Powerful LED work light for added convenience
- CAT IV 600V/CAT III 1000V safety rating and IP67 waterproof and dust-tight housing
- Includes
  - Test leads
  - Type K temperature probe with banana plug adapter
  - Magnetic hanging strap
  - Carrying case
  - Four AAA batteries



MODEL #	STOCK #	DESCRIPTION		
14090T	63018440	TechnicianPRO™ Bluetooth® CAT IV Multimeter		
FUNCTION	RANGE	MAX. RESOLUTION	MAX. ACCURACY (% OF READING)	
AC Voltage	1000V	1mV	±1.0%	
Low-Z (AC Voltage)	600V	1mV	±3.0%	
DC Voltage	1000V	0.1mV	±0.9%	
Low-Z (DC Voltage)	600V	0.1mV	±3.0%	
AC + DC Voltage	1000V	1mV	±2.0%	
AC Current	10A	0.1µA	±1.0%	
DC Current	10A	0.1µA	±1.0%	
Resistance	60MΩ	0.1Ω	±1.5%	
Capacitance	6000µF	10pF	±3.0%	
Frequency	10kHz	0.001Hz	±1.0%	
Duty Cycle	20 to 80%	0.1%	±1.2%	
Temperature	-4°F to 1400°F -20°C to 780°C	0.1°	±1.5%	
Continuity	Audible threshold approx. 50Ω			
Diode Test	Yes			
Dimensions	6.7 x 3.0 x 1.9 in.			
Weight	0.85 lb.			

TEST & MEASUREMENT | MULTIMETERS

# TEST & MEASUREMENT

## TECHNICIANPRO™ TRUERMS CAT IV MULTIMETER

14070T



This rugged multimeter offers a CAT IV safety rating and an IP67 waterproof and dust tight housing. With TrueRMS readings, a Low-Z measurement function, backlit controls, and a powerful built-in work light, it has the features needed for the professional electrician.

- Features automatic power-off
- Lighted controls and backlit display allow use in dimly lit areas
- Low-Z function eliminates false readings from "ghost" voltage
- TrueRMS readings provide higher accuracy on AC circuits
- Includes magnetic hanging strap for hands free operation
- Powerful LED work light for added convenience
- CAT IV 600V/CAT III 1000V safety rating and IP67 waterproof and dust tight housing
- Built-in test lead storage
- Includes
  - Test leads
  - Type K temperature probe with banana plug adapter
  - Magnetic hanging strap
  - Carrying case
  - Four AAA batteries



MODEL #	STOCK #	DESCRIPTION	
14070T	63018240	TechnicianPRO™ TrueRMS CAT IV Multimeter	
FUNCTION	RANGE	MAX. RESOLUTION	MAX. ACCURACY (% OF READING)
AC Voltage	1000V	1mV	±1.0%
Low-Z (AC Voltage)	600V	1mV	±3.0%
DC Voltage	1000V	0.1mV	±1.0%
Low-Z (DC Voltage)	600V	0.1mV	±3.0%
AC Current	10A	0.1µA	±1.5%
DC Current	10A	0.1µA	±1.0%
Resistance	60MΩ	0.1Ω	±1.5%
Capacitance	6000µF	10pF	±3.0%
Frequency	10kHz	0.001Hz	±1.0%
Duty Cycle	20 to 80%	0.1%	±1.2%
Temperature	-4°F to 1400°F -20°C to 780°C	0.1°	±2.0%
Continuity	Audible threshold approx. 50Ω		
Diode Test	Yes		
Dimensions	6.7 x 3.0 x 1.9 in.		
Weight	0.85 lb.		

TEST & MEASUREMENT | MULTIMETERS

# TEST & MEASUREMENT

## TECHNICIANPRO™ AUTO RANGING CAT IV MULTIMETER

14060S



This rugged multimeter offers a CAT IV safety rating and an IP67 waterproof and dust tight housing. With 11 measuring functions, backlit controls, and a powerful built-in work light, it's fully equipped for a wide range of applications.

- Features automatic power-off
- 11 measuring functions plus MAX/MIN
- Lighted controls and backlit display allow use in dimly lit areas
- Powerful LED work light for added convenience
- Includes magnetic hanging strap for hands free operation
- Rugged IP67 waterproof and dust tight housing
- CAT IV 600V/CAT III 1000V safety rating, UL listed
- Built-in test lead storage
- Includes
  - Test leads
  - Type K temperature probe with banana plug adapter
  - Magnetic hanging strap
  - Carrying case
  - Four AAA batteries



DURABILITY CERTIFIED



MODEL #	STOCK #	DESCRIPTION		
14060S	63028740	TechnicianPRO™ Auto-ranging CAT IV Multimeter		
FUNCTION	RANGE	MAX. RESOLUTION	MAX. ACCURACY (% OF READING)	
AC Voltage	1000V	1mV	±1.0%	
DC Voltage	1000V	0.1mV	±1.0%	
AC Current	10A	0.1µA	±1.5%	
DC Current	10A	0.1µA	±1.0%	
Resistance	60MΩ	0.1Ω	±1.5%	
Capacitance	4000µF	10pF	±3.0%	
Frequency	10kHz	0.001Hz	±1.0%	
Duty Cycle	1 to 99.9%	0.1%	±1.2%	
Temperature	-4°F to 1400°F -20°C to 780°C	0.1°	±3.0%	
Continuity	Audible threshold approx. 30Ω			
Diode Test	Yes			
Dimensions	6.7 x 3.0 x 1.9 in.			
Weight	0.85 lb.			

TEST & MEASUREMENT | MULTIMETERS



# TEST & MEASUREMENT

## RESIDENTIALPRO™ BLUETOOTH® CAT III MULTIMETER

13090T



This Bluetooth® enabled multimeter in combination with Southwire's MApp™ mobile app allows you to view, record, and share readings on your smartphone. With TrueRMS and Low-Z readings, a rugged waterproof and dust proof housing, and built-in flashlight, this compact multimeter can be used in a wide range of applications.

- Features automatic power-off
- Bluetooth® interface for viewing, recording and sharing using Southwire's MApp™ mobile app
- TrueRMS readings provide higher accuracy on AC circuits
- Low-Z function eliminates false readings from "ghost" voltage
- Powerful LED work light for added convenience
- Rugged IP67 waterproof and dust tight housing
- CAT III 600V safety rating, UL listed
- Built-in test lead storage
- Includes
  - Test leads
  - Type K temperature probe with banana plug adapter
  - Three AAA batteries



MODEL #	STOCK #	DESCRIPTION	
13090T	63016040	ResidentialPRO™ Bluetooth® CAT III Multimeter	
FUNCTION	RANGE	MAX. RESOLUTION	MAX. ACCURACY (% OF READING)
AC Voltage	600V	1mV	±1.0%
Low-Z (AC Voltage)	300V	1mV	±1.5%
DC Voltage	600V	0.1mV	±1.0%
Low-Z (DC Voltage)	300V	0.1mV	±1.5%
AC Current	10A	1mA	±2.5%
DC Current	10A	1mA	±2.0%
Resistance	40MΩ	0.1Ω	±1.5%
Capacitance	4000μF	10pF	±3.0%
Frequency	10kHz	0.001Hz	±1.0%
Duty Cycle	1.0 to 99.9%	0.1%	±1.2%
Temperature	0°F to 1400°F -18°C to 760°C	0.1°	±2.0%
Continuity	Audible threshold: approx. 50Ω		
Diode Test	Yes		
Dimensions	5.8 x 2.7 x 2.0 in.		
Weight	0.70 lb.		

TEST & MEASUREMENT | MULTIMETERS

# TEST & MEASUREMENT

## RESIDENTIALPRO™ TRUERMS CAT III MULTIMETER

13070T



With 11 measurement functions including TrueRMS readings, Low-measurement features, and a rugged waterproof and dust-proof housing, this compact multimeter has the features needed to get the job done. A built-in flashlight provides added convenience.

- Features automatic power-off
- TrueRMS readings provide higher accuracy on AC circuits
- Low-Z function eliminates false readings from "ghost" voltage
- 11 measuring functions plus MAX/MIN
- Powerful LED work light for added convenience
- Rugged IP67 waterproof and dust tight housing
- CAT III 600V safety rating, UL listed
- Built-in test lead storage
- Includes
  - Test leads
  - Type K temperature probe with banana plug adapter
  - Three AAA batteries



DURABILITY CERTIFIED



MODEL #	STOCK #	DESCRIPTION	
13070T	63015040	ResidentialPRO™ TrueRMS CAT III Multimeter	
FUNCTION	RANGE	MAX. RESOLUTION	MAX. ACCURACY (% OF READING)
AC Voltage	600V	1mV	±1.5%
Low-Z (AC Voltage)	300V	1mV	±1.5%
DC Voltage	600V	0.1mV	±0.8%
Low-Z (DC Voltage)	300V	0.1mV	±0.8%
AC Current	10A	1mA	±3.0%
DC Current	10A	1mA	±2.5%
Resistance	40MΩ	0.1Ω	±1.2%
Capacitance	4000μF	10pF	±3.0%
Frequency	10kHz	0.001Hz	±1.2%
Duty Cycle	0.1 to 99.9%	0.1%	±1.2%
Temperature	-4°F to 1400°F -20°C to 760°C	0.1°	±3.0%
Continuity	Audible threshold approx. 40Ω		
Diode Test	Yes		
Dimensions	5.8 x 2.7 x 2.0 in.		
Weight	0.70 lb.		

TEST & MEASUREMENT | MULTIMETERS

# TEST & MEASUREMENT

## RESIDENTIALPRO™ AUTO RANGING CAT III MULTIMETER

13050S



With 11 measuring functions, an easy-to-read backlit display, and a rugged IP67 waterproof and dust-proof housing, this compact multimeter is perfect for general use. A built-in flashlight provides added convenience.

- Features automatic power-off
- 11 Measuring functions plus MAX/MIN
- Backlit 4,000-count display with bar graph
- Powerful LED work light for added convenience
- Rugged IP67 waterproof and dust tight housing
- CAT III 600V safety rating UL listed
- Built-in test lead storage
- Includes
  - Test leads
  - Type K temperature probe with banana plug adapter
  - Three AAA batteries



DURABILITY CERTIFIED



MODEL #	STOCK #	DESCRIPTION	
13050S	63014540	ResidentialPRO™ Auto ranging CAT III Multimeter	
FUNCTION	RANGE	MAX. RESOLUTION	MAX. ACCURACY (% OF READING)
AC Voltage	600V	1mV	±1.5%
DC Voltage	600V	0.1mV	±0.8%
AC Current	10A	1mA	±3.0%
DC Current	10A	1mA	±3.0%
Resistance	40MΩ	0.1Ω	±1.2%
Capacitance	4000μF	10pF	±3.0%
Frequency	10kHz	0.001Hz	±1.2%
Duty Cycle	0.1 to 99.9%	0.1%	±1.2%
Temperature	-4°F to 1400°F -20°C to 760°C	0.1°	±3.0%
Continuity	Audible threshold approx. 50Ω		
Diode Test	Yes		
Dimensions	5.8 x 2.7 x 2.0 in.		
Weight	0.70 lb.		

TEST & MEASUREMENT | MULTIMETERS

# TEST & MEASUREMENT

## AUTOSELECTING CAT IV MULTIMETER

16030A



Easy-to-use TrueRMS CAT IV multimeter automatically selects AC or DC voltage when connected to live circuits. Added features include a rugged IP67 waterproof and dust tight housing, a built-in flashlight and non-contact AC voltage detector, and auto hold for fast touch-and-hold readings.

- Features automatic power-off
- Automatically selects AC or DC voltage
- Auto hold function for quick touch and hold readings
- TrueRMS readings provide higher accuracy on AC circuits
- Easy-to-read 4,000-count backlit display
- Built-in, non-contact AC voltage detector and powerful work light
- Rugged IP67 waterproof/dust-tight housing
- CAT IV 600V safety rating, UL listed
- Built-in test lead storage
- Includes
  - Test leads
  - Two AAA batteries



TEST & MEASUREMENT | MULTIMETERS

MODEL #	STOCK #	DESCRIPTION	
16030A	63019140	Autoselecting CAT IV Multimeter	
FUNCTION	RANGE	MAX. RESOLUTION	MAX. ACCURACY (% OF READING)
AC Voltage	600V	0.1V	±1.0%
DC Voltage	600V	0.1V	±1.0%
Non-Contact AC Voltage	100 to 600V AC	—	—
Resistance	400kΩ	0.1Ω	±2.0%
Continuity	Audible threshold approx. 50Ω		
Dimensions	5.5 x 3.0 x 1.6 in.		
Weight	0.50 lb.		



# TEST & MEASUREMENT

## COMPACT 3-IN-1 CAT IV MULTIMETER

16020N



Designed for the electrician on the go, this compact CAT IV 3-in-1 combination multimeter with built-in flashlight and non-contact AC voltage detector is a great fit for a crowded tool bag.

- Features automatic power-off
- 3-in-1 Combination: multimeter, work light and non-contact AC voltage detector
- Compact size with integrated test leads is perfect for crowded tool bag
- 10 measuring functions
- Fuse automatically resets itself
- Rugged double-molded housing
- CAT IV 600V safety rating, UL listed
- Built-in test lead storage
- Includes:
  - Multimeter with integrated test leads
  - Two AAA batteries



MODEL #	STOCK #	DESCRIPTION	
16020N	63018640	Compact 3-in-1 CAT IV Multimeter	
FUNCTION	RANGE	MAX. RESOLUTION	MAX. ACCURACY (% OF READING)
AC Voltage	600V	0.1mA	± 1.0%
DC Voltage	600V	0.1mA	± 0.5%
Non-Contact AC Voltage	100 to 600V AC	—	—
AC Current	200mA	0.1µA	±2.5%
DC Current	200mA	0.1µA	±2.0%
Resistance	40MΩ	0.1Ω	±0.8%
Capacitance	100µF	10pF	±3.0%
Frequency	10kHz	0.001Hz	±2.0%
Duty Cycle	0.5 to 99%	0.1%	±2.0%
Continuity	Audible threshold approx. 100Ω		
Diode Test	Yes		
Dimensions	4.6 x 2.3 x 1.4 in.		
Weight	0.32 lb.		

TEST & MEASUREMENT | MULTIMETERS



# TEST & MEASUREMENT

## AUTO-RANGING MULTIMETER

10041N



The Southwire 10041N multimeter provides all the features & functions you'll ever need in an affordable multimeter. Features include a rugged double-molded housing, CAT III 600V safety rating, and a built-in non-contact AC voltage tester. Meets the latest UL safety standards.

- Measures AC/DC voltage up to 600V, Resistance up to 2MΩ, and AC and DC current up to 10A
- CAT III 600V Safety Rating
- Measures capacitance, frequency, temperature and duty cycle. Tests batteries, continuity, and diodes.
- Built-In Non-Contact AC Voltage Detector
- Convenience features include built-in test probe holder, kickstand, easy-change fuses, and accepts Southwire magnetic hanging strap (available separately)
- Built to withstand a 6-foot drop
- Meets the latest UL safety standard
- Backlit LCD Display
- Auto power-off preserves battery life



DURABILITY CERTIFIED



TEST & MEASUREMENT | MULTIMETERS

MODEL #	STOCK #	DESCRIPTION	
10041N	65031240	Auto-Ranging Multimeter	
	RANGE	MAX. RESOLUTION	MAX. ACCURACY (% OF READING)
AC Voltage	600V	1mV	+/- (1.2%+5)
DC Voltage	600V	0.1mV	+/- (0.8%+8)
NCV	50-600V		
AC Current	10A	0.1μA	+/- (1.5%+5)
DC Current	10A	0.1μA	+/- (1.0%+5)
Resistance	40.00MΩ	0.1Ω	+/- (1.2%+5)
Capacitance	100μF	10pF	+/- (5.0%+/- 7)
Frequency	10MHz	0.01Hz	+/- (1.0%+5)
Duty Cycle	99.90%	0.10%	+/- 1.5% +/- 5
Temperature	-22 to 140°F	1°F	+/- 3%
Diode Test		.001V	
Continuity		0.1Ω	
Diode Test		.001V	
Battery Test	1.5V	1mV	+/- (1.0%+5)
Battery Test	9V	10mV	+/- (1.0%+5)
Dimensions	6.1 x 2.9 x 2.1 in.		
Weight	0.5lb.		
Safety Rating	CAT III 600V		

# TEST & MEASUREMENT

## MANUAL RANGING MULTIMETER

10031S



This Southwire general purpose multimeter is perfect for basic electrical repairs & troubleshooting. Features include a rugged double-molded housing, large LCD display, and battery test function. Meets the latest UL safety standards.

- Measures AC/DC voltage up to 600V, Resistance up to 2MΩ, and DC current up to 10A
- CAT III 300V Safety Rating
- Tests batteries and continuity
- Built to withstand a 6-foot drop
- Meets the latest UL safety standard
- Convenience features include built-in test probe holder, kickstand, easy-change fuses, and accepts Southwire magnetic hanging strap (available separately)
- Auto power-off preserves battery life



DURABILITY CERTIFIED



MODEL #	STOCK #	DESCRIPTION	
10031S	65031140	Manual-Ranging Multimeter	
RANGE	MAX. RESOLUTION	MAX. ACCURACY (% OF READING)	
AC Voltage	600V	100mV	+/- (1.2%+10)
DC Voltage	600V	0.1mV	+/- (0.8%+8)
DC Current	10A	1μA	+/- (1.0%+5)
Resistance	2.000MΩ	0.1Ω	+/- (0.8%+5)
Continuity		0.1Ω	
Battery Test	1.5V	1mV	+/- (1.0%+5)
Battery Test	9V	10mV	+/- (1.0%+5)
Dimensions	6.1 x 2.9 x 2.1 in.		
Weight	0.6lb.		
Safety Rating	CAT III 300V		

TEST & MEASUREMENT | MULTIMETERS

# TEST & MEASUREMENT

## MAINTENANCEPRO™ SMART 1000A CLAMP METER

23090T



Southwire's new MaintenancePRO™ 23090T adds Bluetooth® connectivity to a rugged, high-end clamp meter. Used with our MApp™ mobile app, the 23090T lets electricians safely get the measurements they need even in hostile environments. The app can be used to view readings, set up recording sessions, and assemble complete reports right from your mobile phone. The feature set of the 23090T make this the optimal choice for the professional electrician.

- Features automatic power-off
- Bluetooth® interface for viewing, saving and sharing using Southwire's MApp™ mobile app
- Inrush function captures motor start-up current
- 11 measuring functions, plus MAX/MIN
- Precision TrueRMS meter
- Hi-Res 50,000-count backlit display with bargraph
- Built-in, non-contact AC voltage detector and powerful LED work light
- Rugged meter with CAT IV 600V / CAT III 1000V safety rating, UL listed
- Includes:
  - Test leads
  - Type K temperature probe with banana plug adapter
  - Carrying case
  - 9 volt battery



TEST & MEASUREMENT | CLAMP METERS

MODEL #	STOCK #	DESCRIPTION		
23090T	59686840	MaintenancePRO™ Bluetooth® 1000A Clamp Meter		
FUNCTION	RANGE	MAX. RESOLUTION	MAX. ACCURACY (% OF READING)	
AC Current	1000A	10mA	±2.5%	
DC Current	1000A	10mA	±2.5%	
Jaw Opening	1.9" (48mm)	—	—	
AC Voltage	1000V	0.01mV	±1.0%	
DC Voltage	1000V	0.01mV	±1.0%	
Non-Contact AC Voltage	110 to 1000V AC	—	—	
Resistance	50MΩ	0.01Ω	±1.0%	
Capacitance	5mF	10pF	±3.5%	
Frequency	10MHz	0.001Hz	±0.3%	
Duty Cycle	5 to 95%	0.01%	±1.0%	
Temperature	-148°F to 1832°F -100°C to 1000°C	0.1°	±1.0%	
Continuity	Audible threshold approx. 50Ω			
Diode Test	Yes			
Dimensions	9.0 x 3.0 x 1.6 in.			
Weight	0.69 lb.			

# TEST & MEASUREMENT

## MAINTENANCEPRO™ 1000A AC/DC CLAMP METER

23070T



The MaintenancePRO™ 23070T clamp meter is a rugged, high-end AC/DC clamp meter for the professional electrician who needs both AC and DC current measurements. With a UL listed safety rating of CAT IV 600V/CAT III 1000V, this clamp meter is built to get the tough jobs done.

- Features automatic power-off
- 11 measuring functions plus MAX/MIN
- TrueRMS readings provide higher accuracy on AC circuits
- Measures both AC and DC current
- Built-in, non-contact AC voltage detector and powerful LED work light
- 6,000-count backlit display with bar graph
- Rugged meter with CAT IV 600V/CAT III 1000V safety rating, UL listed
- Includes:
  - Test leads
  - Type K temperature probe with banana plug adapter
  - Carrying case
  - 9 volt battery



TEST & MEASUREMENT | CLAMP METERS

MODEL #	STOCK #	DESCRIPTION	
23070T	59686740	MaintenancePRO™ 1000A AC/DC Clamp Meter	
FUNCTION	RANGE	MAX. RESOLUTION	MAX. ACCURACY (% OF READING)
AC Current	1000A	10mA	±2.5%
DC Current	1000A	10mA	±2.5%
Jaw Opening	1.9" (48mm)	—	—
AC Voltage	1000V	1mV	±1.5%
DC Voltage	1000V	0.1mV	±1.0%
Non-Contact AC Voltage	100 to 1000V AC	—	—
Resistance	60MΩ	0.1Ω	±1.0%
Capacitance	6000μF	10pF	±3.0%
Frequency	10MHz	0.001Hz	±1.0%
Duty Cycle	0.5 to 99.9%	0.01%	±1.2%
Temperature	-4°F to 1400°F -20°C to 760°C	0.1°	±3.0%
Continuity	Audible threshold approx. 50Ω		
Diode Test	Yes		
Dimensions	9.0 x 3.0 x 1.6 in.		
Weight	0.69 lb.		

# TEST & MEASUREMENT

## MAINTENANCEPRO™ 1000A AC CLAMP METER

23030T



The MaintenancePRO™ 23030T clamp meter is a rugged, high-end AC clamp meter. With a UL listed safety rating of CAT IV 600V/CAT III 1000V, this clamp meter is built to get the tough jobs done. The feature set of the 23030T make it the new standard in residential, commercial, and maintenance clamp meters.

- Features automatic power-off
- 10 measuring functions plus MAX/MIN
- TrueRMS readings provide higher accuracy on AC circuits
- Powerful LED work light for added convenience
- Built-in, non-contact AC voltage detector
- 6,000-count backlit display with bar graph
- Rugged meter with CAT IV 600V/CAT III 1000V safety rating, UL listed
- Includes:
  - Test leads
  - Type K temperature probe with banana plug adapter
  - Carrying case
  - 9 volt battery



TEST & MEASUREMENT | CLAMP METERS

MODEL #	STOCK #	DESCRIPTION		
23030T	59686640	MaintenancePRO™ 1000A AC Clamp Meter		
FUNCTION	RANGE	MAX. RESOLUTION	MAX. ACCURACY (% OF READING)	
AC Current	1000A	10mA	±2.5%	
Jaw Opening	1.9" (48mm)	—	—	
AC Voltage	1000V	1mV	±1.5%	
DC Voltage	1000V	0.1mV	±1.0%	
Non-Contact AC Voltage	100 to 1000V AC	—	—	
Resistance	60MΩ	0.1Ω	±1.0%	
Capacitance	6000μF	10pF	±3.0%	
Frequency	10MHz	0.001Hz	±1.0%	
Duty Cycle	0.5 to 99.9%	0.01%	±1.2%	
Temperature	-4°F to 1400°F -20°C to 760°C	0.1°	±3.0%	
Continuity	Audible threshold approx. 50Ω			
Diode Test	Yes			
Dimensions	9.0 x 3.0 x 1.6 in.			
Weight	0.69 lb.			



# TEST & MEASUREMENT

## 400A AC/DC TRUE RMS CLAMP METER

21550T



The Southwire 21550T 400A AC/DC clamp meter with True RMS offers the features needed for the professional electrician including True RMS accuracy, the ability to measure both AC and DC current, and a built-in, non-contact, AC voltage detector. Other features included are REL and max/min functions in addition to standard multimeter functions such as resistance, capacitance, continuity, temperature, and diode. This clamp meter also has a third-hand test probe holder and a bright LED worklight. The 21550T is built-to-last and is guaranteed to survive a 6-foot drop.

- 400A AC/DC Current Range
- CAT III 600V Safety Rating
- True RMS Accuracy
- Built-In Non-Contact Voltage Tester
- Third-Hand Test Probe Holder



MODEL #	STOCK #	DESCRIPTION	
21550T	65031840	400A AC/DC True RMS Clamp Meter	
FUNCTION	RANGE	MAX. RESOLUTION	MAX. ACCURACY (% OF READING)
AC Current	400A	0.01A	+/- (2.0%+9)
DC Current	400A	0.01A	+/- (2.0%+5)
AC Voltage	600V	0.001V	+/- (1.0%+5)
DC Voltage	600V	0.1mV	+/- (1.0%+8)
NCV	Yes		
Resistance	40MΩ	0.1Ω	+/- (1.0%+4)
Capacitance	1000μF	0.1nF	+/- (5.0%+/- 7)
Temperature	-5 - 750°F	1°F	+/- 3.0%
Continuity		0.1Ω	
Diode Test		.001V	
Jaw Opening	1.1 in. (28mm)		
Dimensions	9" x 2.7" x 1.4"		
Weight	0.6lb.		
Safety Rating	CAT III 600V		

TEST & MEASUREMENT | CLAMP METERS

# TEST & MEASUREMENT

## 400A AC TRUE RMS CLAMP METER

21530T



The Southwire 21530T 400A AC clamp meter with True RMS offers the features needed for the professional electrician. It provides True RMS accuracy, AC current up to 400A, and a built-in, non-contact, AC voltage detector. Common multimeter functions include AC/DC voltage up to 600V, resistance, capacitance, continuity, temperature, and diode. The 21530T also provides a third-hand test probe holder and LED worklight for added convenience. The 21530T is built-to-last and is guaranteed to survive a 6-foot drop. Great for the professional.

- 400A AC Current Range
- CAT III 600V Safety Rating
- True RMS Accuracy
- Built-In Non-Contact Voltage Tester
- Third-Hand Test Probe Holder



MODEL #	STOCK #	DESCRIPTION	
21530T	65031640	400A AC True RMS Clamp Meter	
FUNCTION	RANGE	MAX. RESOLUTION	MAX. ACCURACY (% OF READING)
Feature	Range	Max. Resolution	Max. Accuracy (% of Reading )
AC Current	400A	0.01A	+/-(-2.0%+9)
AC Voltage	600V	0.001V	+/-(-1.0%+5)
DC Voltage	600V	0.1mV	+/-(-1.0%+8)
NCV (non-contact AC Voltage)	Yes		
Resistance	40MΩ	0.1Ω	+/- (1.0%+4)
Capacitance	1000μF	0.1nF	+/-(-3.0%+5)
Temperature	-5°F - 750°F	1°F	+/- 3.0%
Continuity		0.1Ω	
Diode Test		0.001V	
Jaw Opening	1.1 in. (28mm)		
Dimensions	9" x 2.7" x 1.4"		
Weight	0.6 lb.		
Safety Rating	CAT III 600V		

# TEST & MEASUREMENT

## 400A AC CLAMP METER

21510N



The Southwire 21510N 400A AC clamp meter offers the features needed for routine electrical repairs. In addition to measuring AC current up to 400A, the 21510N measures AC and DC voltage up to 600V plus provides common multimeter functions such as resistance, capacitance, continuity, temperature, and diode. The 21510N offers a built-in, non-contact AC voltage detector and a powerful LED worklight for working in dimly lit areas. The 21510N also features a third-hand test probe holder for added convenience. This CAT III clamp meter is designed to survive a 6-foot drop, making it built to last. Great for basic electrical work.

- 400A AC current range
- CAT III 600V safety rating
- Built-in non-contact voltage tester
- Third-hand test probe holder



MODEL #	STOCK #	DESCRIPTION	
21510N	65031540	400A AC Clamp Meter	
FUNCTION	RANGE	MAX. RESOLUTION	MAX. ACCURACY (% OF READING)
Feature	Range	Max. Resolution	Max. Accuracy (% of Reading )
AC Current	400A	0.01A	+/- (2.0%+9)
AC Voltage	600V	0.001V	+/- (1.0%+5)
DC Voltage	600V	0.1mV	+/- (1.0%+8)
NCV (non-contact AC Voltage)	Yes		
Resistance	40MΩ	0.1Ω	+/- (1.0%+4)
Capacitance	1000μF	0.1nF	+/- (3.0%+5)
Temperature	-5°F - 750°F	1°F	+/- 3.0%
Continuity		0.1Ω	
Diode Test		0.001V	
Jaw Opening	1.1 in. (28mm)		
Dimensions	9" x 2.7" x 1.4"		
Weight	0.6 lb.		
Safety Rating	CAT III 600V		

TEST & MEASUREMENT | CLAMP METERS

# TEST & MEASUREMENT

## LCD VOLTAGE TESTER 600V AC/DC

41171N



Get a multimeter and non-contact voltage detector in one pocket tester. Great for beginner or experienced electricians. Features one of the largest backlit LCD displays in this category. Performs three essential electrician tasks: voltage detection, voltage testing, and continuity. Tests AC and DC voltage up to 600V. Features a built-in non-contact voltage detector and tests continuity with both visual and audible indicators. Fits comfortably in the pocket and has replaceable test leads. 5-year, no hassle warranty.

- Backlit LCD Display
- Built-in Non Contact Voltage Detector with Self Test
- Tests Continuity with visual & audible confirmation
- Bright LED Flashlight
- 0-600V AC measurement range
- 0-600V DC measurement range
- Replaceable Test Leads
- CAT IV 600V Safety Rated
- 6.5' drop tested



DURABILITY CERTIFIED



MODEL #	STOCK #	DESCRIPTION
41171N	65112140	LCD Voltage Tester 600V AC/DC
Voltage	6-600V AC/DC	
Safety Rating	CAT IV 600 V, Class 2, Double Insulation	
NCV Detection Range	100 V AC to 1000 V AC	
Drop Protection	6.5 feet (2 meters)	
AC Frequency Range	50 Hz/60 Hz	
Operating Temperature	32 °F to 104 °F (0°C to 40°C)	
Storage Temperature	14 °F to 122 °F (-10°C to 50°C)	

TEST & MEASUREMENT | VOLTAGE TESTERS

# TEST & MEASUREMENT

## VOLTAGE TESTER 600V AC 400V DC

41161N



An ideal test tool for the beginning electrician or for use as a back-up tester for more experienced electricians. Perfect for trade schools too. Performs three essential functions: voltage detection, voltage testing, and continuity. Features an easy-to-read LED display and tests AC voltage up to 600V and DC voltage up to 400V. Has a built-in non-contact voltage detector and tests continuity. Fits comfortably in the pocket, accepts a hanging strap, and has replaceable test leads. 5-year, no hassle warranty.

- Bright LED Display
- Built-in Non Contact Voltage Detector with Self Test
- Tests Continuity with visual & audible confirmation
- Bright LED Flashlight
- Indicates AC voltage from 12-600V AC in 9 steps
- Indicates DC voltage from 9-400V in 9 steps with polarity indication
- Replaceable Test Leads
- CAT IV 600V Safety Rated
- 6.5' drop tested



MODEL #	STOCK #	DESCRIPTION
41161N	65112040	Voltage Tester 600V AC 400V DC
Voltage LED Steps	AC: 12, 24, 48, 120, 208, 240, 277, 480, 600 DC: 9, 12, 24, 36, 48, 60, 110, 220, 400	
Safety Rating	CAT IV 600 V, Class 2, Double Insulation	
NCV Detection Range	100 V AC to 1000 V AC	
Drop Protection	6.5 feet (2 meters)	
AC Frequency Range	50 Hz/60 Hz	
Operating Temperature	32 °F to 104 °F (0°C to 40°C)	
Storage Temperature	14 °F to 122 °F (-10°C to 50°C)	

TEST & MEASUREMENT | VOLTAGE TESTERS



# TEST & MEASUREMENT

## VOLTAGE TESTER 480V AC 110V DC

41151S



The 41151S compact voltage and GFCI tester features a LED display. It's a simple and safe way to test for live circuits, measure voltage, and test if GFCI circuits are functioning properly. This pocket tester tests AC voltage up to 480V and DC voltage up to 110V.

- Bright LED Display
- Indicates AC voltage from 12-480V in 6 steps
- Indicated DC voltage from 9-110V in 6 steps with polarity indication
- Tests GFCI outlets and circuits
- CAT III 600V safety rating
- Tamper resistant outlet compatible
- Test probes store concealed
- 6.5' drop tested



DURABILITY CERTIFIED



6.5' DROP TESTED

MODEL #	STOCK #	DESCRIPTION
41151S	65111940	Voltage Tester 480V AC 110V DC
Voltage LED Steps	AC: 12, 24, 48, 120, 240, 480 DC: 9, 12, 24, 36, 48, 110	
Safety Rating	CAT III 600V	
Drop Protection	6.5 feet (2 meters)	
AC Frequency Range	50 Hz - 60 Hz	
Operating Temperature	32 °F to 104 °F (0°C to 40°C)	
Storage Temperature	14 °F to 122 °F (-10°C to 50°C)	

# TEST & MEASUREMENT

## 4-WAY VOLTAGE TESTER

40141S



The 4-Way Voltage Tester is a handy, pocket sized tester that checks live AC voltage from 120 to 480 volts and DC voltage from 160 to 600 volts in four easy steps. The 40141S is easy-to-read and features a convenient, compact design.

- Tests AC voltage from 120V to 480V
- Tests DC voltage from 160V to 600V
- CAT III 600V safety rating
- Built-in test leads and handy pocket clip
- No batteries required
- Test probes conveniently store in the back of the tester and are spaced to fit standard AC outlets
- UL listed
- Built to withstand a 6-foot drop



MODEL #	STOCK #	DESCRIPTION
40141S	65032240	4-Way Voltage Tester
Voltage LED Steps	AC: 120, 240, 277, 480 DC: 160, 330, 380, 600	
AC Operating Frequency	60Hz	
Safety Rating	CAT III 600V	
Drop Protection	6.5 feet (2 meters)	
Operating Temperature	32 °F to 104 °F (0°C to 40°C)	
Storage Temperature	14 °F to 122 °F (-10°C to 50°C)	

# TEST & MEASUREMENT

## ADVANCED DUAL RANGE NCV 12-1000V AC

40150N



Advanced dual range NCV 12-1000V & 100-1000V AC.

- Features automatic power-off
- High power rear flashlight and forward facing flashlight
- Thinner probe tip for working with wall outlets
- Green LED means Power on
- Flashing red LED with beeper means voltage is detected
- Low-Battery self test
- High voltage and low voltage modes
- Silent mode
- IP67 Waterproof



DURABILITY CERTIFIED



MODEL #	STOCK #	DESCRIPTION
40150N	63020740	40150N Advanced Dual Range NCV 12-1000V AC
AC Detection Range	12-1000V & 100-1000V AC	
Safety Rating	CAT IV 1000V	
Frequency Range	50/60Hz	
Batteries	Two AAA	
Operating Temperature	32°F to 104°F (0°C to 40°C)	
Storage Temperature	14°F to 140°F (-10°C to 60°C)	
Dimensions	6.23 x 0.83 x 0.99 in (158 x 21 x 25 mm)	
Humidity	80% max	

# TEST & MEASUREMENT

## NCV DETECTOR 50-600V AC PRO

40136N



### NCV detector 50-600V AC Pro

- Features automatic power-off
- Flashlight now 2X brighter
- Thinner probe tip for working with wall outlets
- Green LED means power-on
- Flashing red LED with beeper means voltage detected
- Low battery self test
- Silent mode
- Flash and beep rate increase as the detector gets closer to the voltage source helping the user pinpoint live circuits



MODEL #	STOCK #	DESCRIPTION
40136N	59992440	40136N NCV Detector 48-600V AC Pro
AC Detection Range	50-600V AC	
Safety Rating	CAT IV 600V	
Frequency Range	50/60Hz	
Batteries	Two AAA	
Operating Temperature	32°F to 104°F (0°C to 40°C)	
Storage Temperature	14°F to 140°F (-10°C to 60°C)	
Dimensions	6.23 x 0.83 x 0.99 in (158 x 21 x 25 mm)	
Humidity	80% max	

TEST & MEASUREMENT | NCV

# TEST & MEASUREMENT

## 40126N NCV DUAL RANGE 24-600V AC

40126N



NCV dual range 24-600V & 100-600V AC.

- Flashlight now 2X brighter
- Thinner probe tip for working with wall outlets
- Green LED means Power on
- Flashing red LED with beeper means voltage detected
- Low battery self test
- High voltage and low voltage mode



TEST & MEASUREMENT | NCV

MODEL #	STOCK #	DESCRIPTION
40126N	59992240	40126N NCV Dual Range 24-600V AC
AC Detection Range	24-600V & 100-600V AC	
Safety Rating	CAT IV 600V	
Frequency Range	50/60Hz	
Batteries	Two AAA	
Operating Temperature	32°F to 104°F (0°C to 40°C)	
Storage Temperature	14°F to 140°F (-10°C to 60°C)	
Dimensions	6.23 x 0.83 x 0.99 in (158 x 21 x 25 mm)	
Humidity	80% max	



# TEST & MEASUREMENT

## NCV DETECTOR 100-600V AC

40116N



NCV detector 100-600V AC.

- Flashlight now 2X brighter
- Thinner probe tip for working with wall outlets
- Green LED means power on
- Flashing red LED with beeper means voltage detected
- Low battery self test



MODEL #	STOCK #	DESCRIPTION
40116N	59992040	40116N NCV Detector 100-600V AC
AC Detection Range	100-600V AC	
Safety Rating	CAT IV 600V	
Frequency Range	50/60Hz	
Batteries	Two AAA	
Operating Temperature	32°F to 104°F (0°C to 40°C)	
Storage Temperature	14°F to 140°F (-10°C to 60°C)	
Dimensions	6.23 x 0.83 x 0.99 in (158 x 21 x 25 mm)	
Humidity	80% max	

TEST & MEASUREMENT | GFCI

# TEST & MEASUREMENT

## GFCI RECEPTACLE TESTER

40022S



GFCI receptacle tester quickly identifies the most common wiring faults associated with 3-wire 120V outlets. Just plug it into the outlet and the indicator lights quickly tell you if the outlet is wired correctly. Press the red button to verify that a GFCI circuit is functioning properly.

- Tests standard 120V outlets
- Tests ground fault circuit interrupter (GFCI) outlets & circuits
- Three light indicators identify wiring faults
- Wiring legend on the top and bottom of the tester so it's always easy to see
- UL listed



TEST & MEASUREMENT | TESTER

MODEL #	STOCK #	DESCRIPTION
40022S	65032040	GFCI Receptacle Tester
<input type="checkbox"/> <input type="checkbox"/> <input type="checkbox"/>	Open Ground	Ground contact is not connected
<input type="checkbox"/> <input type="checkbox"/> <input type="checkbox"/>	Open Neutral	Neutral contact is not connected
<input type="checkbox"/> <input type="checkbox"/> <input type="checkbox"/>	Open Hot	Hot contact is not connected
<input type="checkbox"/> <input type="checkbox"/> <input type="checkbox"/>	Hot/Ground Reversed	Hot and ground connections are interchanged
<input type="checkbox"/> <input type="checkbox"/> <input type="checkbox"/>	Hot/Neutral Reversed	Hot and neutral connections are interchanged
<input type="checkbox"/> <input type="checkbox"/> <input type="checkbox"/>	Correct	Receptacle is wired correctly

# TEST & MEASUREMENT

## RECEPTACLE TESTER

40012S



Receptacle Tester quickly identifies the most common wiring faults associated with 120V outlets. Just plug it in and the indicator lights quickly tell you if the outlet is wired correctly.

- Tests standard 120V outlets Performs 6 tests: open ground, open neutral, open hot, hot/ground reversed, hot/neutral reversed, or wired correctly
- Three light indicators identify wiring faults
- Wiring legend on the top and bottom of the tester so it's always easy to see
- UL listed



MODEL #	STOCK #	DESCRIPTION
40012S	65031940	Receptacle Tester
□ □ □	Open Ground	Ground contact is not connected
□ □ □	Open Neutral	Neutral contact is not connected
□ □ □	Open Hot	Hot contact is not connected
■ □ □	Hot/Ground Reversed	Hot and ground connections are interchanged
■ □ □	Hot/Neutral Reversed	Hot and neutral connections are interchanged
□ □ □	Correct	Receptacle is wired correctly

TEST & MEASUREMENT | TESTER

# TEST & MEASUREMENT

## PRO CONTINUITY TESTER WITH REMOTE

40040S



The Southwire 40040S provides a simple way of checking continuity on wire and cables. The bright LEDs and loud pulsating beeper provide a positive indication of continuity and polarity. A detachable remote indicator is included for tracing multiple cable runs.

- Bi-color LEDs determine polarity
- Color coded alligator clips for easy connection
- Wiring legend on tester provides simple operation
- Rugged double-molded housing



MODEL #	STOCK #	DESCRIPTION
40040S	59724840	Pro Continuity Tester with Remote
FUNCTION	RANGE	
Dimensions	4.0 x 2.1 x 1.3 inch	
Weight	0.42 lb. (191g)	

# TEST & MEASUREMENT

## 930°F 12:1 IR THERMOMETER

**31212S**



Southwire's newest dual-laser IR thermometer, the 31212S, is designed for the professional because it's accurate, rugged, and easy-to-use. Perfect for everyday use but loaded with advanced features for ultimate flexibility. Customers appreciate the extra-large, backlit temperature display that's easy to see in almost any environment.

- Designed for the professional
- Dual-laser targeting for precise aiming
- 12:1 optics for extra-long distance accuracy
- Extra large, uncluttered, backlit temperature display
- Adjustable emissivity - higher accuracy when measuring different materials
- Displays temperature in °F or °C
- Protective carrying pouch included
- Continuous Measurement. Built-in tripod mount and LOCK Mode
- High and Low Temperature Alarms
- MAX, MIN, AVE, DIF Mode



TEST & MEASUREMENT | IR THERMOMETER

MODEL #	STOCK #	DESCRIPTION	
31212S	65111840	930°F 12:1 IR Thermometer	
Measurement Range	-26°F - 932°F (-32°C - 500°C)		
Working Temperature	32°F - 122°F (0°C - 50°C)		
Working Relative Humidity	<90% RH (non-condensing)		
Storage Temperature	-4°F - 140°F (-20°C - 60°C)		
Accuracy	<b>SURFACE TEMPERATURE</b>	<b>ACCURACY</b>	<b>AMBIENT TEMPERATURE</b>
	-26°F ≤ t ≤ 32°F	+/- (3.6°F + 0.1°F/°F)	69.8°F - 77 °F
	32°F < t ≤ 932°F	+/- 3.6°F or 1.8% of reading, whichever is greater	
	-32°C ≤ t ≤ 0°C	+/- (1.8°C + 0.1°C/°C)	21°C - 25 °C
0°C < t ≤ 500°C	+/- 1.8°C or 1.8% of reading, whichever is greater		
D:S Ratio (Distance to Spot)	12:1 (Applies for 90% for the measuring signal)		
Emissivity	0.1 ~ 1.0 (Adjustable)		
Display Resolution	0.1°F (0.1°C)		



# TEST & MEASUREMENT

## 750°F 10:1 IR THERMOMETER

31011F



When you need an IR thermometer that's simple and economical, the Southwire 31011F is the right model for you. Just point-and-shoot for accurate and repeatable temperature measurements around the house or on the job.

- Simple & economical
- Single-laser targeting
- 10:1 optics for long distance accuracy
- Fixed emissivity (0.95)
- Displays temperature in °F or °C
- Low-battery indicator
- Built for the Work Environment: 6-Ft Drop Rating



TEST & MEASUREMENT | IR THERMOMETER

MODEL #	STOCK #	DESCRIPTION
31011F	65111640	750°F 10:1 IR Thermometer
Measurement Range	-4°F - 752°F (-20°C - 400°C)	
Working Temperature	32°F - 122°F (0°C - 50°C)	
Working Relative Humidity	<90% RH (non-condensing)	
Storage Temperature	-4°F - 140°F (-20°C - 60°C)	
Accuracy	<b>SURFACE TEMPERATURE</b>	<b>ACCURACY</b>
	-4°F ≤ t ≤ 32°F	+/- (4°F + 0.1°F/°F)
	32°F < t ≤ 752°F	+/- 4°F or +/- 2% of reading, whichever is greater
	-20°C ≤ t ≤ 0°C	+/- (2°C + 0.1°C/°C)
	0°C < t ≤ 400°C	+/- 2.0°C or 2% of reading, whichever is greater
		<b>AMBIENT TEMPERATURE</b>
		69.8°F - 77 °F
		21°C - 25 °C
D:S Ratio (Distance to Spot)	10:1 (Applies for 90% for the measuring signal)	
Emissivity	Fixed at 0.95	
Display Resolution	0.1°F (0.1°C)	

# TEST & MEASUREMENT

## 41210S CIRCUIT BREAKER FINDER WITH GFCI

41210S



The circuit breaker finder pinpoints the specific breaker powering the circuit being worked on. Eliminates guessing and unwanted power outages caused by tripping the wrong breaker.

- Advanced design quickly and reliably pinpoints single breaker without service interruption
- Tests GFCI outlets
- For use on energized circuits
- Includes:
  - 41210S Transmitter and Receiver
  - 3-prong to 2-prong adapter
  - 9 volt battery
- Available accessory: 60030S Adapter Kit

MODEL #	STOCK #	DESCRIPTION
41210S	58292140	Circuit Breaker Finder with GFCI
Dimensions	7.56 in. x 2.52 in. x 1.65 in.	

# TEST & MEASUREMENT

## TEST LEAD KIT

60010S



60010S Test lead kit includes universal replacement leads for all Southwire meters.

- UL listed
- CAT IV 600V/CAT III 1000V
- Includes alligator clip attachments (CAT III 600V)

MODEL #	STOCK #	DESCRIPTION
60010S	58292940	Test Lead Kit

## ADAPTER KIT FOR CIRCUIT BREAKER FINDER

60030S



This adapter kit includes a light socket adapter that allows for rapid location of circuit breakers connected to lighting fixtures. Also includes alligator clips that allow the transmitter to be connected to unterminated branch circuit wiring.

- For use with 41210S circuit breaker finder

MODEL #	STOCK #	DESCRIPTION
60030S	58292240	Adapter Kit for Circuit Breaker Finder

## DRAGON CLIPS

60100S



Universal dragon clips are extra large alligator clips that attach to multimeter and clamp meter test probes. They allow you to grip wires and connectors for easier and safer measurements.

- Large dragon clip with a jaw capacity of 0.8"
- Universal design fits any test lead with a 2mm diameter probe tip
- 1,000 Volt maximum for AC/DC

MODEL #	STOCK #	DESCRIPTION		
60100S	65161540	Dragon Clip Kit 20mm & 27mm		
	HEIGHT	WIDTH	DEPTH	WEIGHT
60100S	9.7"	3.3"	1.3"	0.35 lbs

# TEST & MEASUREMENT

## ELECTRICAL TEST KIT

### 10037K



The Southwire electrical test kit combines three of Southwire's most popular test and measurement products into one convenient kit. Ideal for household repairs and electrical troubleshooting.

- 10031S Manual ranging multimeter is CAT III 300V safety rated. It measures AC/DC voltage, resistance, and DC current. Also tests batteries and continuity.
- 40117N Non-contact AC voltage detector has a 90-1000V detection range, CAT IV 1000V safety rating, automatic self test, and features a bright LED flashlight
- 40012S Receptacle tester verifies wiring errors in standard 3-wire AC outlets. Just plug it into the receptacle. LED indicators and wiring legend identify faults
- All products are UL listed and meet the latest UL safety standards
- All products are built to withstand a 6-foot drop

MODEL #	STOCK #	DESCRIPTION
10037K	65031340	Electrical Test Kit

MODEL #	STOCK #	DESCRIPTION	
10031S	65031140	Manual-Ranging Multimeter	
FEATURE	RANGE	MAX. RESOLUTION	MAX. ACCURACY (% OF READING)
AC Voltage	600V	100mV	+/- (1.2%+10)
DC Voltage	600V	0.1mV	+/- (0.8%+8)
DC Current	10A	1µA	+/- (1.0%+5)
Resistance	2.000MΩ	0.1Ω	+/- (0.8%+5)
Continuity		0.1Ω	
Battery Test	1.5V	1mV	+/- (1.0%+5)
Battery Test	9V	10mV	+/- (1.0%+5)
Dimensions	6.1 x 2.9 x 2.1 in.		
Weight	0.6lb.		
Safety Rating	CAT III 300V		

MODEL #	STOCK #	DESCRIPTION
40117N	N/A	1000V AC Voltage Detector
Detection Voltage Range	90V AC to 1000V AC	
Frequency Range	50/60Hz	
Safety Rating	CAT IV 1000V	

MODEL #	STOCK #	DESCRIPTION
40012S	65031940	Receptacle Tester
Identifies	Open Ground, Open Neutral, Open Hot, Hot/Ground Reversed, Hot/Neutral Reversed, Correct Wiring	

# TEST & MEASUREMENT

## CLAMP METER TEST KIT

20025K

Tester kit consisting of 200A AC clamp meter, 120V receptacle tester with GFCI test, and an AC line splitter for measuring current on common household plugs and with appliances.

- 200A AC Current
- 600V AC/DC Voltage
- 6-Foot Drop Durability
- UL Listed AC Line Splitter
- GFCI Receptacle Tester



MODEL #	STOCK #	DESCRIPTION		
20025K	65031440	Clamp Meter Kit		
HEIGHT	WIDTH	DEPTH	WEIGHT	
20025K	11.81"	7.95"	3.71"	1.32 lbs





# TEST & MEASUREMENT

## AC LINE SPLITTER

60040S



60040S AC line splitter is the safe and easy way to measure the current draw of plug-in appliances and electronics. Great for troubleshooting and home energy audits.

- AC line splitter allows a clamp meter to measure AC current of plug-in appliances and other electrical devices without having to cut and separate the conductors of the power cord
- Just plug the line splitter into an AC outlet and plug the appliance into the line splitter. Place the clamp meter around the square opening in line splitter to measure current (compatible with North American outlets only)
- Provides 10X resolution: Divide the clamp meter current reading by 10 to accurately determine the amps being drawn
- CAT III 300V safety rating
- UL Listed

MODEL #	STOCK #	DESCRIPTION		
60040S	65032440	AC Line Splitter		
	HEIGHT	WIDTH	DEPTH	WEIGHT
60040S	4.97"	2.3"	1.58"	.25 lbs



# VOICE DATA VIDEO

Southwire offers a full line of VDV tools including cable cutters, strippers, crimpers and punchdown tools, as well as cable tracers and testers. Our goal is to provide professional tools that exceed customers' expectations for quality, performance and features — tools that make a difference on the real-world jobsite.



# VDV TESTERS

## PROFESSIONAL TELEPHONE TEST SET

**B600**



The B600 Professional Telephone Test Set features Hi-Z monitoring, Pulse and Tone (DTMF), 10 number speed dial, and polarity indication in a rugged, double-molded housing.

- Hi-Z monitoring will not disrupt network traffic
- High and low volume settings, polarity LED, tone & pulse modes
- ABN (angled bed of nails) clips with rugged RJ45 and RJ11 plug
- Last number redial and memory to store up to 10 phone numbers
- Double-molded housing for comfort and durability



### ELECTRICAL

Humidity	10% to 90% non-condensing
Loop Limit	2.4K $\Omega$ maximum at 48VDC (nominal 15 mA minimum loop current)
DC Resistance (Talk Mode)	150 $\Omega$ typical at 80mA current
AC Impedance (Monitor Mode)	HI-Z: 100k $\Omega$ @ 1KHz RING: 600 $\Omega$ @ 1KHz

### ROTARY DIAL OUTPUT

Pulsing Rate	20pps +/-0.5pps
Percent Break	60% +/-2%
Interdigit Interval	500 ms typical
Leakage During Break	>50K $\Omega$

### PHYSICAL

Dimensions	10.12" x 2.43" x 2.49" (25.7cm x 6.17cm x 6.33 cm)
Weight	0.6875 lbs.
Battery	CR2032 (included)

## SPECIFICATIONS

### MODEL # STOCK # DESCRIPTION

B600	58742940	Professional Telephone Test Set
B610C	58743040	Replacement Leads for Buttset

# VDV TESTERS

## PROFESSIONAL VOICE DATA VIDEO CABLE MAPPER & TESTER



**M300P**

The M300P Cable Mapper quickly tests voice, data, and video cabling for common wiring faults including split pairs. Rugged, double-molded body includes silicone port covers to protect the ports and an easy-to-read backlit LCD screen.

- Quickly checks for faults on voice, data, and video cables
- Identifies correct wiring, opens, shorts, reversals, miswires, split pairs, and shielded cables
- Test patch cables or installed cables
- Built for durability: Double injection-molded housing provides a soft, impact absorbing rubber over a strong ABS frame
- Maps multiple cable runs with included RJ45 & Coax "F" ID remotes (5 of each are included)
- Built-in tone generator for cable tracing (separate amplifier probe required)



<b>CABLE TYPES</b>	Shielded or Unshielded: Cat 7, Cat 7a, Cat 6a, Cat 6, Cat 5e, Cat 5, Cat 3, Coax
<b>MINIMUM CABLE LENGTH FOR SPLIT PAIR DETECTION</b>	1.6' (0.5m)
<b>MAXIMUM COAX CABLE LENGTH</b>	1000' (305m)
<b>MAXIMUM COAX CABLE RESISTANCE</b>	100 ohms maximum DC
<b>DIMENSIONS</b>	7.13" x 2.86" x 1.61" (18.1cm x 7.3cm x 4.1 cm)
<b>WEIGHT</b>	0.78 lbs.

## SPECIFICATIONS

MODEL #	STOCK #	DESCRIPTION
M300P	58744340	Professional VDV Cable Mapper

# VDV TESTERS

## PROFESSIONAL DATA CABLE MAPPER & TESTER



**M400TP**

The M400TP Mapper for Data Cable quickly tests twisted pair data cable for common wiring faults including split pairs. It even sends a tone and features a backlit LCD screen, double-molded housing, and silicone port cover.

- Easy-to-read LCD display with backlight
- Port cover protects RJ45 port from dust and debris
- Rugged double-molded housing with snap-in remote
- Identifies correct wiring, opens, shorts, reversals, miswires, split pairs, and shielded cables
- Built-in tone generator for tracing cables (separate amplifier probe required)



<b>CABLE TYPES</b>	Shielded or Unshielded: Cat 7, Cat 7a, Cat 6a, Cat 6, Cat 5e, Cat 5, Cat 3
<b>MINIMUM CABLE LENGTH FOR SPLIT PAIR DETECTION</b>	1.6' (0.5m)
<b>BATTERIES</b>	Two "AAA" 1.5V
<b>DIMENSIONS</b>	4.80" X 2.05" X 1.30" (12.2cm X 5.2cm X 3.3 cm)
<b>WEIGHT</b>	0.281 lbs.

## SPECIFICATIONS

MODEL #	STOCK #	DESCRIPTION
M400TP	58744840	Professional Data Cable Mapper & Tester





# VDV TESTERS

## VIDEO CABLE MAPPER & TESTER



**M500CX4**

The M500CX4 speeds troubleshooting and installation by testing and identifying up to four cable TV remote wall outlets at a time. It includes four color-coded remotes.

- Easy-to-understand LED display
- Test patch cables or installed cables
- Identify up to four coax cable remote locations - includes 4 color-coded ID remotes
- Double-molded housing for durability and grip
- Auto power off



<b>MAX. TESTING LENGTH</b>	10,000 feet (3km) maximum
<b>BATTERIES</b>	Four LR44 Batteries
<b>DIMENSIONS</b>	5.4" x 1.26" x 0.98" (13.7cm x 3.2cm x 2.5cm)
<b>WEIGHT</b>	0.196 lbs.

## SPECIFICATIONS

MODEL #	STOCK #	DESCRIPTION
M500CX4	58744940	Video Cable Mapper & Tester



# VDV TESTERS

## PHONE OUTLET TESTER



**P700**

The P700 checks phone outlets - Lines 1 and 2 - for correct wiring, line reversed, AC ring voltage, and dead line conditions.

- Quickly checks phone outlets for correct wiring
- Identifies correct wiring, line reversed, AC ring voltage, and dead line conditions
- Tri-color LED display
- Color legend printed on tester makes interpreting results simple
- Tests both Line 1 and Line 2
- Double-molded housing for durability and grip



## SPECIFICATIONS

MODEL #	STOCK #	DESCRIPTION
---------	---------	-------------

P700	58745340	Phone Outlet Tester
------	----------	---------------------



# VDV TESTERS

## DATA & VIDEO CABLE TESTER



**M550**

The M550 gives instant continuity status for both twisted pair and coaxial cables. Features rugged, double-molded tester body with on-board remote storage and an easy-to-interpret LED display.

- Quickly detects wiring faults in network and coax cables
- Test patch cables or installed cables
- Identifies correct wiring, opens, shorts, reversals, miswires, split pairs, and shielded cables
- Auto power off
- Tests shielded and unshielded twisted pair and coax
- Includes adapter cables



**RJ45**



**F-CONNECTOR**

<b>CABLE TYPES</b>	Shielded or Unshielded: Cat 7, Cat 7a, Cat 6a, Cat 6, Cat 5e, Cat 5, Cat 3, Coax
<b>MINIMUM CABLE LENGTH FOR SPLIT PAIR DETECTION</b>	1.6' (0.5m)
<b>MAXIMUM COAX CABLE LENGTH</b>	1000' (305m)
<b>BATTERIES</b>	Two "AAA" 1.5V
<b>DIMENSIONS</b>	5.11" x 2.05" x 1.30" (13.0cm x 5.2cm x 3.3cm)
<b>WEIGHT</b>	0.281 lbs.

## SPECIFICATIONS

MODEL #	STOCK #	DESCRIPTION
M500CX4	58745040	Data/Video Cable Tester



# VDV TESTERS

## PROFESSIONAL TONE & PROBE KIT



The T100PK Professional Tone & Probe Kit quickly traces non-energized cabling. It is powerful enough to trace cables behind walls but sensitive enough to identify individual conductors.

- Quickly trace non-energized cables - even behind walls
- Positive cable detection: tone changes when wires are shorted
- Toner features on-board test lead storage
- Probe features replaceable tip, LED flashlight, LED signal strength indicator, rear facing speaker, and stereo headphone jack
- T100PK includes T110TG and T120AP

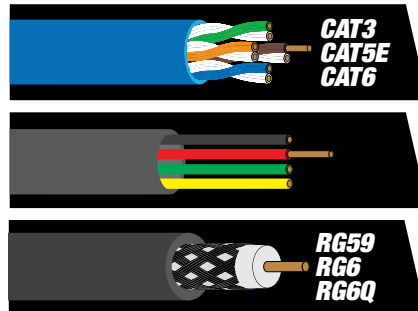

### T110TG TONE GENERATOR

Continuous Tone Frequency	1.06kHz nominal
Over Voltage Protection	60VDC in Toner/Polarity Mode
Output Power in Tone Mode	+9.65dbm into 600 ohms
Auto-Off	30 minutes
Open Circuit Voltage in Continuity Mode	8.2VDC with fresh battery
Battery	One 9V battery
Case Dimensions	4.02" x 2.58" x 2.36" (10.2cm x 6.5cm x 6cm)
Weight	0.50 lbs.

### T120AP ANALOG PROBE

Battery	One 9V battery
Case Dimensions	9.33" x 1.70" x 1.51" (23.7cm x 4.3cm x 3.8cm)
Weight	0.313 lbs.

## SPECIFICATIONS

MODEL #	STOCK #	DESCRIPTION
T100PK	58746340	Professional Tone & Probe Kit
T110TG	58746440	Tone Generator
T120AP	58746540	Amplifier Probe

# VDV TESTERS

## UNIVERSAL WIRE TRACING KIT



**T200K**

The T200K is a self-contained kit for tracing a variety of cable types. It includes a belt-mount case with five adapter cables, separate toner, and probe. The probe features an LED flashlight for cable tracing in low-light areas.

- Belt-mount, rugged carrying case
- Double-molded housings for durability and grip
- Provides audible and visual indication
- Five adapter cables can be stored in the case and plugged into RJ11 jack on transmitter
- Traces non-energized low-voltage cables

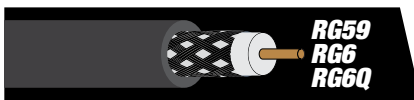

<b>tone signal frequency</b>	2.72kHz nominal
<b>tone output power</b>	+24dbm into 600 ohms
<b>tone auto-off</b>	30 minutes
<b>battery (transmitter and receiver)</b>	Two "AAA" 1.5V Batteries in each unit
<b>case dimensions</b>	7.06" x 3.19" x 2.04" (17.9cm x 8.1cm x 5.2cm)
<b>tone dimensions</b>	5.17" x 0.94" x 1.32" (13.2cm x 2.4cm x 3.4cm)
<b>probe dimensions</b>	6.18" x 0.94" x 1.32" (15.7cm x 2.4cm x 3.4cm)
<b>weight</b>	0.70 lbs.

## SPECIFICATIONS

MODEL #	STOCK #	DESCRIPTION
T200K	58746640	Multipurpose Wire Tracing Kit



# VDV HAND TOOLS

## PROFESSIONAL DATACOMM SNIPS

ESP-1



These snips provide very precise control and offer a patented design with unique spring-loaded action.

- Ergonomic, spring-loaded design for precise control
- Lock holds snips closed for storage
- Double-dipped, textured grip
- Strips 19 AWG and 23 AWG
- Serrated blade grips wire as it cuts



## SPECIFICATIONS

MODEL #	STOCK #	DESCRIPTION
ESP-1	58743740	Professional DataComm Snips

# VDV HAND TOOLS

## KEY STRIP TOOL FOR TWISTED PAIR

SK-T1



The key strip tool for twisted pair quickly strips outer cable jackets from CAT 3, 5, 5e and 6 data cable.

- Quickly removes outer cable jacket
- Three positions for different size cables
- Cost effective



### SPECIFICATIONS

MODEL #	STOCK #	DESCRIPTION
SK-T1	58746140	SK-T1 Key Strip Tool for Twisted Pair

## COAX TRIGGER STRIP TOOL

ST-C1



The rotary-style coax stripper performs a fast and precise two-level strip in one easy step.

- Standard two-level strip exposes 1/4" of center conductor and 1/4" of shield braid
- Innovative "trigger" design improves control and fits comfortably in hand
- Use with RG59, RG6 and RG6 quad shield coax

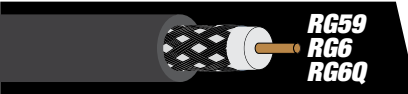

### SPECIFICATIONS

MODEL #	STOCK #	DESCRIPTION
ST-C1	58746240	Coax Trigger Strip Tool

# VDV HAND TOOLS

## COAX PREP TOOL

CPT-CF1



The time-saving coax prep tool is a 3-in-1 tool for loosening/tightening cable TV "F" connectors from jacks. It also flares the cable jacket and holds the connector during assembly.

- Easily loosens stubborn connectors
- Flares coax jacket for easy connector insertion
- Holds cable TV "F" connector during cable insertion
- Double-molded grip for long-lasting comfort

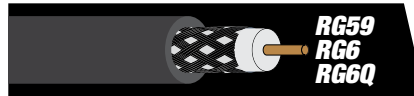

## SPECIFICATIONS

MODEL #	STOCK #	DESCRIPTION
CPT-CF1	58743440	Coax Prep Tool

# VDV HAND TOOLS

## PROFESSIONAL IMPACT PUNCHDOWN TOOL

PDTP-K1



Includes both 110 and 66 style blades  
Easy to pull out wire hook and spudger tools

The professional impact punchdown tool includes 110 & 66 twist-to-lock blades and features unique pull-out accessory tools in a comfortable, durable tool body.

- Terminates twisted pair category cable into wall jacks and patch panels for phone and data communications
- Includes both 110 and 66-style, long life, metal injection molded blades
- Comfortable double-molded tool body
- Wire hook and spudger accessory tools pull out one-handed with easy-to-use thumb studs
- Covered blade storage

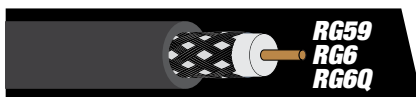

### BLADES AVAILABLE SEPARATELY

- B1 Reversible 66 Punch/110 Cut-Only Punchdown Blade
- B2 Reversible 110 Cut/Punch Punchdown Blade
- B3 Reversible 66 Cut/Punch Punchdown Blade

## SPECIFICATIONS

MODEL #	STOCK #	DESCRIPTION
PDTP-K1	58745540	Professional Impact Punchdown Tool

## COMFORT GRIP 110-STYLE PUNCHDOWN TOOL

PDTC-1



The comfort grip 110-style punchdown tool easily terminates 110-style blocks on patch panels and wall jacks.

- Punch down 110-style jacks or patch panels
- Soft rubber comfort grip
- 110-style blade terminates cable and trims excess wire



## SPECIFICATIONS

MODEL #	STOCK #	DESCRIPTION
PDTC-1	58745440	Comfort Grip 110-Style Punchdown Tool

# VDV HAND TOOLS

## NETWORK TOOL KIT

### KIT-TP1



This network tool kit includes the tools you need to cut, strip, terminate, and install data cabling.

- Complete kit for terminating data cable
- Make custom length patch cables
- Includes tools to cut, strip, and terminate data cabling
- Kit includes:
  - Compact 3-in-1 Cut/Strip/Crimp Tool
  - Comfort Grip Punchdown Tool
  - Reversible Screwdriver
  - 10 RJ45 Connectors
  - Rugged Tool Case

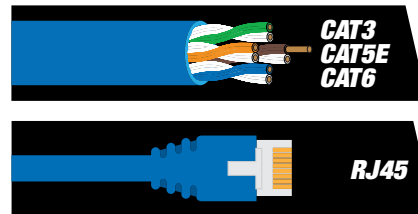

## SPECIFICATIONS

MODEL #	STOCK #	DESCRIPTION
KIT-TP1	58744140	Network Tool Kit



# VDV HAND TOOLS

## RATCHETING PHONE & DATA CRIMP TOOL

RJCR-T1



The RJCR-T1 ratcheting phone & data crimp tool cuts and strips voice and data cable. It also crimps RJ45 data connectors as well as RJ11/RJ12 phone modular plugs.

- Ratcheting tool cuts, strips, and crimps phone and data cable
- Comfortable double-molded grips help to orient the tool
- Compatible with standard RJ45, RJ11/RJ12, and RJ22 modular plugs
- Locks closed for easy storage

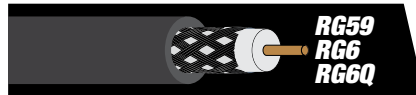

## SPECIFICATIONS

MODEL #	STOCK #	DESCRIPTION
RJCR-T1	58745840	Ratcheting Phone & Data Crimp Tool

# VDV HAND TOOLS

## MULTI-CONNECTOR COMPRESSION COAX CRIMP TOOL

### CCM-C1



When you need versatility, multi-connector compression coax crimp tool is 3-way adjustable to work with F, BNC, and RCA compression connectors as well as RG59/6/6Q and RG7/11 coax cable.

- 3-way chuck can be positioned for cable TV "F", RCA, and BNC connectors
- Rotatable connector cradle accommodates RG59, RG6Q, RG6 as well as larger RG7 and RG11 cable
- Thumb-wheel for fine-tuning crimping length
- For cable TV, satellite, security, and home theater applications
- Comfortable double-molded grips are indexed to help orient the tool

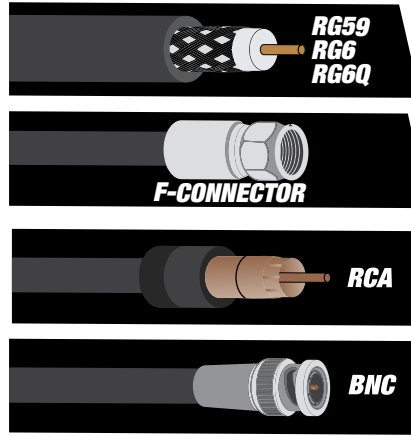

### SPECIFICATIONS

MODEL #	STOCK #	DESCRIPTION
CCM-C1	58743240	Multi-Connector Compression Coax Crimp Tool

# VDV HAND TOOLS

## COMPACT COMPRESSION COAX CRIMP TOOL FOR "F" CONNECTORS

**CCF-C1**



The CCF-C1 compact compression coax crimp tool securely attaches "F" type connectors to coax cable in one easy step. CCF-C1 features double-molded handles to provide a comfortable grip and powerful crimping force.

- Compatible with RG59, RG6, and RG6Q coaxial cable
- Simple, compact, and powerful
- Double-molded handles for durability and grip

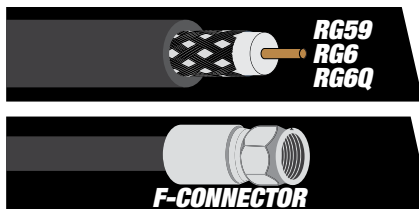

### SPECIFICATIONS

MODEL #	STOCK #	DESCRIPTION
CCF-C1	58743140	Compact Compression Coax Crimp Tool - Cable TV "F"



# VDV HAND TOOLS

## CABLE TV TOOL KIT

### KIT-C1



This cable TV tool kit includes all the tools you need to cut, strip, crimp, and install "F" connectors onto coax cable.

- Complete kit for terminating coax
- Make custom length coax patch cables
- All 3 tools included to cut, strip, and crimp coax
- Kit includes:
  - Round Cable Cutter
  - Radial "Trigger" Stripper
  - Compression Crimper for "F" Connectors
  - 10 "F" Connectors for RG6 Coax
  - Rugged Tool Case

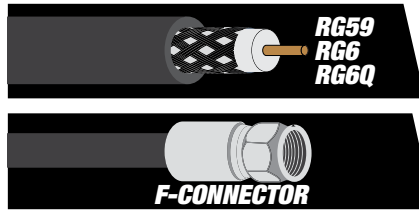

## SPECIFICATIONS

MODEL #	STOCK #	DESCRIPTION
KIT-C1	58744040	Cable TV Tool Kit



# CABLE PULLING

Southwire cable pulling equipment sets the industry standard. We've revolutionized these tools to make them faster, safer, and smarter than ever before. With Southwire cable pulling equipment on your jobsite, experience an increase in safety, efficiency, and profitability.





# CABLE PULLING

## MAXIS® XD10 EXTREME DUTY CABLE PULLER

XD10



 WE'VE GOT IT  
**MADE IN AMERICA™**



LVFS-01  
Footswitch  
Included



The MAXIS® XD10 EXTREME duty cable puller is designed to get the job done, thriving in the most extreme pulling conditions. The XD10 allows you to pull faster and safer up to 10,000 lbs.

- Vertical capstan design - allows operator to safely stand to the side during cable pulls
- Smooth elevation control: operates with handle or 18V cordless drill helping to eliminate any lifting
- Pulls up to 10 ft. of extra wire without extending the boom
- Gear reducer design allows for increased efficiency, durability, and power while maintaining low operating temperature
- 10,000 lb. peak pulling force with a continuous pulling rate of 7,000 lbs.
- Conduit adapter sizes 2" - 4" included, 5" & 6" adapters sold separately
- Includes LVFS-01 low voltage footswitch
- Self contained: ready to pull with no need for additional parts or equipment for set up
- Single person set up and operation: quickly adapts from underground to overhead pulls
- Collapsible down to 40"H x 26"W x 70"L to fit through standard doorways and ease of transport
- Add Southwire's Triggers Wireless Safety Switch System (sold separately) for complete control over the cable pulling application

### SPECIFICATIONS

MODEL #	STOCK #	DESCRIPTION		
XD10	59190402	MAXIS® XD10 EXTREME Duty Cable Puller		
HEIGHT	LENGTH	WIDTH	WEIGHT	WARRANTY
40"	70"	26"	598 lb.	1 year
CAPACITY				
Pulling Speed Low:		Pulling Speed High:		
at 2,000 lb.	11 feet per minute		at 2,000 lb.	21 feet per minute
at 4,000 lb.	10 feet per minute		at 4,000 lb.	18 feet per minute
at 6,000 lb.	9 feet per minute		-	-
at 8,000 lb.	8 feet per minute		-	-
at 10,000 lb.	7 feet per minute		-	-

## XD10 BOLT DOWN ADAPTER

XD10BD



 WE'VE GOT IT  
**MADE IN AMERICA™**

Floor mount adapter for XD10.

- Easily attaches to the XD10
- Does not require disassembly of cable puller
- Simple bolt down adapter for when overhead pulling is required

### SPECIFICATIONS

MODEL #	STOCK #	DESCRIPTION		
XD10BD	59727001	Maxis® XD10 Bolt Down Kit		
HEIGHT	WIDTH	DEPTH	WEIGHT	
XD10BD	18"	14"	16"	35 lb.

CABLE PULLING | PULLERS

# CABLE PULLING

## MAXIS® 6K CABLE PULLER

**M6K-M**  
**M6K**  
**PC100**



LVFS-01 Footswitch



MAXIS® 6K with motor and puller cart

A 6,000 pound cable puller that sets up in less than 2 minutes.

- One person, 2 minute set up
- 2 pulling speeds: 12 feet per minute on low (at no load) and 44 feet per minute on high (at no load)
- Quickly adapts from underground to overhead pulls
- No need to bolt to the ground on most pulls
- 6,000 lb. peak capacity with continuous rating of 3,500 lb. on low
- Can adapt to virtually any wire pull
- Vertical capstan design - allows operator to safely stand to the side during cable pulls
- Can be anchored to most trucks' standard 2" receiver hitch
- Able to pull up to 9 ft. of wire out of the conduit
- Includes 5 conduit adapters 2" - 4" Included, 5" and 6" sold separately
- Includes puller cart with tool bag and LVFS-01 Low Voltage Footswitch
- Add Southwire's Triggers Wireless Safety Switch System (sold separately) for complete control over the cable pulling application

## SPECIFICATIONS

MODEL #	STOCK #	DESCRIPTION			
M6K-M	57648501	MAXIS® 6K (with motor) - includes five conduit adapters (2", 2.5", 3", 3.5", 4"), PC100 cart, and LVFS-01 footswitch			
M6K	57142901	MAXIS® 6K (no motor) - includes five conduit adapters (2", 2.5", 3", 3.5", 4"). PC100 cart, and LVFS-01 footswitch			
PC100	56829601	Puller cart for M3K and M6K pullers			
LVFS-01	64602801	Low-voltage footswitch			
		HEIGHT	WIDTH	DEPTH	WEIGHT
M6K-M		45"	21"	20"	194.5 lb.
PC100		50"	21"	17.5"	40 lb.

Milwaukee, Super Hawg, Hole Hawg are trademarks, service marks, or trade names of Milwaukee Electric Tool Corporation ("Milwaukee Electric Tool Corporation's Intellectual Property").



Conduit Adapters (included): 4", 3.5", 3", 2.5", 2"

# CABLE PULLING

## CORDLESS MAXIS® 3K CABLE PULLER



**M3K-BAT  
PC100**



Southwire's M3K-BAT is your complete solution for a truly cordless cable pulling experience. Eliminates the need to be near an electrical outlet on the jobsite or having to run long extension cords. No additional hardware required.

- One person, 2 minute set up
- 2 pulling speeds: 25 feet per minute on low (at no load) and 100 feet per minute on high (at no load)
- Quickly adapts from underground to overhead pulls
- No need to bolt to the ground on most pulls
- Able to pull up to 8 ft. of wire out of the conduit
- 3,000 lb. peak capacity with continuous rate of 1,500 lb. on low
- Can adapt to virtually any wire pull
- Vertical capstan design - allows operator to safely stand to the side during cable pulls
- Can be anchored to most trucks' standard 2" receiver hitch
- Includes 5 conduit adapters: 2", 2.5", 3", 3.5", and 4"
- Puller cart with tool bag
- Completely cordless cable puller. No outlet? No problem!
- No additional hardware required.
- 12.0 AH capacity for extended run life.

### SPECIFICATIONS

MODEL #	STOCK #	DESCRIPTION		
M3K-BAT	65242040	Includes Maxis M3K cable puller, PC-100 puller cart, cordless motor, rapid charger, and 12A battery pack		
PC100	56829601	Puller cart for M3K and M6K pullers		
	HEIGHT	WIDTH	DEPTH	WEIGHT
M3K-BAT	45"	20"	20"	148.5 lb.
PC100	50"	21"	17.5"	40 lb.

*Milwaukee, Super Hawg, Hole Hawg are trademarks, service marks, or trade names of Milwaukee Electric Tool Corporation ("Milwaukee Electric Tool Corporation's Intellectual Property").*



# CABLE PULLING

## MAXIS® 3K CABLE PULLER

M3K-M  
M3K  
PC100



LVFS-01  
Footswitch

The MAXIS® 3K is a smaller and more lightweight version of Southwire's 6K puller but shares the same design features and functionality.

- One person, 2-minute set-up
- 2 pulling speeds: 25 feet per minute on low (at no load) and 100 feet per minute on high (at no load)
- Quickly adapts from underground to overhead pulls
- No need to bolt to the ground on most pulls
- Able to pull up to 8 additional feet of wire out of the conduit
- 3,000 lb. peak capacity with continuous rate of 1,500 lb. on low
- Can adapt to virtually any wire pull
- Can be anchored to most trucks' standard 2" receiver hitch
- Includes 5 conduit adapters: 2", 2.5", 3", 3.5", and 4"
- Includes puller cart with tool bag and LVFS-01 Low Voltage Footswitch

## SPECIFICATIONS

MODEL #	STOCK #	DESCRIPTION		
M3K-M	57648401	MAXIS® 3K (with motor) - includes cable puller, motor, PC100 cart, five conduit adapters (2", 2.5", 3, 3.5", 4"), and LVFS-01 low voltage footswitch		
M3K	57143101	MAXIS® 3K (no motor) - includes cable puller, PC100 cart, five conduit adapters (2", 2.5", 3, 3.5", 4"), and LVFS-01 low voltage footswitch		
PC100	56829601	Puller cart for M3K and M6K pullers		
	HEIGHT	WIDTH	DEPTH	WEIGHT
M3K-M	45"	20"	20"	148.5 lb.
PC100	50"	21"	17.5"	40 lb.

Milwaukee, Super Hawg, Hole Hawg are trademarks, service marks, or trade names of Milwaukee Electric Tool Corporation ("Milwaukee Electric Tool Corporation's Intellectual Property").



# CABLE PULLING

## MAXIS® XD1 CABLE PULLER

XD1



Safer, faster, and more efficient way to pull low voltage, branch home runs, lighting cables, and small circuit sized wires.

- Continuous pulling up to 600 lbs.
- Lightweight and portable
- One person setup and operation
- Accepts most commercial 18V cordless drills (drill not included)
- Removable capstan to facilitate polyline removal
- Expandable length up to 34.5 inches
- Polyline pin on capstan to prevent slippage during the pull
- Anodized for corrosion resistance
- Field replaceable chuck adapter
- 600 lbs of constant pulling force with 1000 lbs peak pulling force

### SPECIFICATIONS

MODEL #	STOCK #	DESCRIPTION		
XD1	65090901	Maxis® XD1 Cable Puller		
	HEIGHT	WIDTH	DEPTH	WEIGHT
XD1	8.75"	8"	28.5"	8.8 lb.





# CABLE PULLING

## XDTM EXTREME DUTY TENSION MONITOR

### XDTM



10,000 lb. in-line tension monitor.

- Records elapsed time, tension, pull speed, and distance pulled
- Working load: 10,000 lbs
- Large, soft touch button controls
- Built-in USB port with USB flash drive (included) for easy data extraction
- Back lit screen allows for easy viewing
- Anodized aluminum frame for durability
- Tie-off slots
- Covers full range of rope sizes
- Built-in rechargeable battery for long life
- Includes padded hard-shell case with wheels and extendable handle for easy transport to the jobsite
- No disassembly for rope insertion
- Includes mounting pins for fast and easy assembly to Southwire's XD10 cable puller

### SPECIFICATIONS

MODEL #	STOCK #	DESCRIPTION		
XDTM	65111501	Extreme Duty Tension Monitor - 10,000 lb.		
HEIGHT	WIDTH	DEPTH	WEIGHT	
XDTM	10.50"	20.50"	7.50"	41 lb.



# CABLE PULLING

## MAXIS® CABLE FEEDER

### MCF01



Designed and built specifically to accommodate Southwire SIMpull™ wire, the Maxis® Cable Feeder is a revolutionary way to feed wire quickly and efficiently.

- Designed and built specifically to accommodate Southwire SIMpull™ wire
- Quick 1 person, 2 minute set up and operate
- Forward and reverse, variable speed, and feeds up to 30' per minute
- May be used with Triggers® Safety System for simultaneous feeder/puller control
- Easily adjust wire tension, even during operation
- Feeds wire sizes from 1/2" - 3 1/2" cable
- Swivel casters and solid rubber tires that will never go flat for easy jobsite mobility
- Digital footage meter allows easy monitoring of approximate conductor length being fed
- Uses grooved roller design with increased surface area for greater traction force (no pneumatic tires)
- Dual anchoring mechanism
- Maximum traction force: single conductor 800 lb., 4 SIMpull™ THHN 500 MCM conductors 1,600 lb. capacity
- Cable capacity: 8 x 250 MCM, 6 x 500 MCM, 5 x 750 MCM
- Triggers Adapter FB-01 (sold separately) allows Southwire's Triggers Wireless Safety Switch System to be used with the Maxis Cable Feeder

### SPECIFICATIONS

MODEL #	STOCK #	DESCRIPTION		
MCF01	58133301	MAXIS® Cable Feeder		
FB-01	63159401	Triggers Adapter		
	HEIGHT	WIDTH	DEPTH	WEIGHT
MCF01	35"	26"	44"	366 lb.
FB-01	2.5"	4"	12"	2 lb.

### FB-01



# CABLE PULLING

## TRIGGERS® WIRELESS SAFETY SWITCH SYSTEM

### TSS01



Allows members at each end of the wire pull, as well as the observers, the ability to stop the pull instantaneously if needed. Offers your crew the highest level of safety, allowing full control over pulling and feeding applications

- Works with all brands of electrically driven equipment
- Saves time by avoiding unnecessary stops and restarts
- High-visibility LED status lights
- Monitors amperage draw indicating when to switch puller to low speed
- Triggers® Wireless safety switch system is UL and FCC certified and carries an IP55 rating
- Foot controls contain dual redundant activation switches
- Military grade 3.4 amps per hour lithium-ion battery packs
- Handheld remotes can control pull from any location
- High range: communicates up to 1500' between walls and 1.5 miles line of sight

### SPECIFICATIONS

MODEL #	STOCK #	DESCRIPTION		
TSS01	59713201	Triggers® Wireless Safety Switch System		
	HEIGHT	WIDTH	DEPTH	WEIGHT
TSS01	12.54"	21.5"	16.42"	30 lb.

## LOW VOLTAGE FOOT SWITCH

### LVFS01



- Works with all brands of electrically driven equipment
- Shuts off equipment when over amperage condition is indicated
- Monitors for under voltage condition which can cause an over amperage condition
- Bright LED lights for easy viewing in bright sunlight
- Redundant switches for added reliability
- Impact-resistant metal construction
- Low voltage indicator light for detecting low voltage situations
- Built-in over amperage protection to protect equipment and motors

### SPECIFICATIONS

MODEL #	STOCK #	DESCRIPTION		
LVFS01	64602801	Low Voltage Foot Switch		
	HEIGHT	WIDTH	DEPTH	WEIGHT
LVFS01	4.25"	6.25"	12.25"	4 lb.

# CABLE PULLING

## SIMpull™ CABLE GUIDE SYSTEM

CGS01



WE'VE GOT IT  
**MADE IN AMERICA™**

Integrated guidance system allowing wire and cable to be routed from a reel into a conduit or cable tray without human intervention.

- Designed to eliminate the manual handling of service and feeder conductors during wire pulls
- Completely customizable for any wire and cable installation
- Minimizes labor effort during installation
- Reduces the risk of jobsite injuries
- Specialized storage cart for ease of transportation
- Roller guides direct and protect wire and cable along any desired path
- Universal clamps attach the system to the reel jacks, switch gear or panel box

### SPECIFICATIONS

MODEL #	STOCK #	DESCRIPTION	HEIGHT	WIDTH	DEPTH	WEIGHT
CGS01	59893101	SIMpull™ Cable Guide System	43"	25"	67"	300 lb.



CABLE PULLING | ACCESSORIES

# CABLE PULLING

## CABLE PULLER TRIPODS

**P3T01**  
**P6T02**



**M3K and M6K Tripods attach to MAXIS® cable pullers to make underground wire pulls simple and easy.**

- Easily attaches to the M3K or M6K cable pullers
- Helps when pulling from transformer pads, vaults and meter bases
- Set up in two minutes
- Helps to pull out extra wire
- Great solution for pulling wire from manholes

### SPECIFICATIONS

MODEL #	STOCK #	DESCRIPTION
P3T01	56822201	Tripod for MAXIS® 3K
P6T02	56829401	Tripod for MAXIS® 6K
MODEL #	SIZE	WEIGHT
P3T01	Adjustable height: 3ft - 6ft    Adjustable leg width: 13in - 50in	43 lb.
P6T02	Adjustable height: 3ft - 6ft    Adjustable leg width: 13in - 50in	45 lb.

*Milwaukee, Super Hawg, Hole Hawg are trademarks, service marks, or trade names of Milwaukee Electric Tool Corporation ("Milwaukee Electric Tool Corporation's Intellectual Property").*





# CABLE PULLING

## QWIKrope®



An innovative, high performance pulling rope that is UV-resistant, lightweight, and ultra low-stretch for all of your feeder and circuit wire needs.

- High performance pulling rope made from ultra high molecular weight polyethylene fibers
- 24% reduction in the coefficient of friction, as compared to traditional pulling ropes
- 12 strand single braided 9/16" pulling rope with a breaking strength of 32,000 lb., pound for pound stronger than steel
- 2 sizes for all your circuit wire pulls: 1/8" pulling rope with 1,100 lb. of breaking strength, and 1/4" pulling rope with 7,500 lb. of breaking strength
- Dual factory installed pulling eyes
- Does not absorb water, no rope rot
- Need only one size rope (9/16") for feeder conductor that pulls up to 10,000 pounds
- 1/8" QWIKrope® can easily be vacuumed into any conduit run up to 290 ft.
- 9/16" QWIKrope® recommended for use with all MAXIS® cable pullers

## SPECIFICATIONS

MODEL #	STOCK #	DIAMETER	LENGTH	AVG. BREAKING STRENGTH	TOTAL WEIGHT
SPR183	58387401	1/8"	300 ft.	1,100 lb.	2.5 lb.
SPR186	64865701	1/8"	600 ft.	1,100 lb.	5 lb.
SPR143	58387501	1/4"	300 ft.	7,500 lb.	6.5 lb.
SPR146	58526301	1/4"	600 ft.	7,500 lb.	11 lb.
SPR963	58305601	9/16"	300 ft.	32,000 lb.	26 lb.
SPR966	58305701	9/16"	600 ft.	32,000 lb.	52 lb.
SPR969	58305801	9/16"	900 ft.	32,000 lb.	77 lb.
SPR9612	58305901	9/16"	1,200 ft.	32,000 lb.	103 lb.

# CABLE PULLING

## STRAIGHT AND SWIVEL CLEVISES



Connects pulling head and pulling rope to eliminate winding and tangling of rope and wire during cable pulls.

### MS158

- Swivel diameter 1 5/8"
- Maximum rope size: 1"
- Designed to pass over sheaves, pulleys and rollers
- Pin roller design added for larger diameter rope and for added strength by evenly spreading load pressure

### MS114

- Swivel diameter 1 1/4"
- Maximum rope size: 5/8"
- Designed to pass over sheaves, pulleys and rollers
- Pin roller design added for larger diameter rope and for added strength by evenly spreading load pressure

### RC114

- Clevis diameter 1 1/4"
- Maximum rope size: 5/8"
- Connects to cable grip and pulling rope
- Designed to pass over sheaves, pulleys, and rollers

### RC158

- Clevis diameter 1 5/8"
- Maximum rope size: 1"
- Connects to cable grip and pulling rope
- Designed to pass over sheaves, pulleys, and rollers

## SPECIFICATIONS

MODEL #	STOCK #	DESCRIPTION
MS158	57178001	10,000 LB Swivel Clevis
MS114	57178101	6,000 LB Swivel Clevis
RC114	56830601	6,000 LB Straight Clevis
RC158	56830701	10,000 LB Straight Clevis

HEIGHT	WIDTH	DEPTH	WEIGHT
4"	4"	4"	2 lb.
4"	4"	4"	1 lb.
2"	2"	4"	1 lb.
2"	2"	4"	1 lb.

# CABLE PULLING

## DOUBLE BRAIDED PULLING ROPE



Cable pulling rope designed for high breaking strength. The double braid weave provides enhanced strength and increased pulling capability.

- Polyester double braid
- High strength

## SPECIFICATIONS

MODEL #	STOCK #	DIAMETER	LENGTH	AVG. BREAKING STRENGTH	TOTAL WEIGHT
P-963	56823501	9/16"	300 ft.	14,000 lb.	50 lb.
P-966	56823601	9/16"	600 ft.	14,000 lb.	75 lb.
P-583	56823701	5/8"	300 ft.	18,000 lb.	63 lb.
P-586	56823901	5/8"	600 ft.	18,000 lb.	85 lb.
P-786	56824001	7/8"	600 ft.	31,000 lb.	240 lb.
P-789	57791301	7/8"	900 ft.	31,000 lb.	269 lb.
P-7812	56824101	7/8"	1200 ft.	31,000 lb.	298 lb.

## HIGH TENSILE STRENGTH QWIKLINE™ POLY LINE

PL500



PL6500



Tangle resistant poly line for light-duty cable or rope pulling applications.

- Ready-to-use storage containers quickly dispense a tangle-free line
- Line is resistant to rot and mildew
- Used to pull electrical and communication wire
- Made in the USA

## SPECIFICATIONS

MODEL #	STOCK #	DESCRIPTION			
PL6500	58280540	QWIKline™ POLY LINE 6500' 210 lb Tensile Strength			
PL2200	65130440	QWIKline™ POLY LINE 2200' 500 lb Tensile Strength			
PL500	58280640	QWIKline™ POLY LINE 500' 210 lb Tensile Strength			
	HEIGHT	WIDTH	DEPTH	WEIGHT	TENSILE STRENGTH
PL6500	13"	11"	13"	11.3 lb.	210 lb.
PL2200	13"	11"	11"	8.0 lb.	500 lb.
PL500	7.9"	3"	8"	0.5 lb.	210 lb.



**WE'VE GOT IT  
MADE IN AMERICA™**

# CABLE PULLING

## QWIKtapes™ CONDUIT MEASURING TAPE

**SWMT1250-3000S**

Thread, measure, and pull wire with one product.



- Printed with sequential, easy-to-read foot markings
- Low coefficient of friction minimizes duct melting
- Easily blown through conduit

### SPECIFICATIONS

MODEL #	STOCK #	DESCRIPTION	LENGTH (FT.)	WIDTH (IN.)	TENSILE STRENGTH (LBS.)
SWCMT160-3000S	64584901	Conduit Measuring Tape 160-LB x 3000-FT Spool	3000	3/16	160
SWMT400-4500P	64585001	QWIKtape™ 400-LB x 4500-FT Bucket	4500	3/16	400
SWMT1250-3000S	64585101	QWIKtape™ 1250-LB x 3000-FT Spool	3000	1/2	1250
SWQT1250-500S	65128740	QWIKtape™ 1250-LB x 500-FT Spool	500	1/2	1250
SWQT1250-1000S	65128840	QWIKtape™ 1250-LB x 1000-FT Spool	1000	1/2	1250
SWQT1250-1500S	65128940	QWIKtape™ 1250-LB x 1500-FT Spool	1500	1/2	1250
SWQT1250-5000S	65129040	QWIKtape™ 1250-LB x 5000-FT Spool	5000	1/2	1250
SWDQT1250-3000S	65129140	QWIKtape™ 1250-LB x 3000-FT Spool - DETECTABLE	3000	1/2	1250
SWMT1800-3000S	64585201	QWIKtape™ 1800-LB x 3000-FT Spool	3000	5/8	1800
SWQT1800-500S	65129240	QWIKtape™ 1800-LB x 500-FT Spool	500	5/8	1800
SWQT1800-1000S	65129340	QWIKtape™ 1800-LB x 1000-FT Spool	1000	5/8	1800
SWQT1800-1500S	65129440	QWIKtape™ 1800-LB x 1300-FT Bucket	1300	5/8	1800
SWDQT1800-3000S	65129640	QWIKtape™ 1800-LB x 3000-FT Spool - DETECTABLE	3000	5/8	1800
SWMT2500-3000S	64585401	QWIKtape™ 2500-LB x 3000-FT Spool	3000	3/4	2500
SWQT2500-500S	65129740	QWIKtape™ 2500-LB x 500-FT Spool	500	3/4	2500
SWQT2500-1000S	65129840	QWIKtape™ 2500-LB x 1000-FT Spool	1000	3/4	2500
SWQT2500-1500S	65130040	QWIKtape™ 2500-LB x 1500-FT Spool	1500	3/4	2500
SWQT2500-5000S	65130140	QWIKtape™ 2500-LB x 5000-FT Spool	5000	3/4	2500
SWDQT2500-3000S	65130340	QWIKtape™ 2500-LB x 3000-FT Spool - DETECTABLE	3000	3/4	2500
PL6500	58280540	QWIKline™ 210-LB x 6500-FT Bucket	6500	N/A	210
PL500	58280640	QWIKline™ 210-LB x 500-FT Canister	500	N/A	210
PL2200	65130440	QWIKline™ 500-LB x 2200-FT Bucket	2200	N/A	500

CABLE PULLING | CONDUIT MEASURING TAPE

# CABLE PULLING

## MAXIS® GRIPS PULLING HEADS



The MAXIS® grips pulling heads are a dual-lock pulling system that uses both a cam lock head and a double braided wire to quickly secure cable to rope without the fear of losing a conductor. These pulling heads provide increased efficiency with 2 minute head preparation.

- Rated at 4,000 lbs. per conductor.
- Holds securely to NO-LUBE® wire
- Disconnect wire from pulling heads in 2 minutes without cutting the wire
- No cutting, stripping or weaving of wire to make pulling head
- Easily moves through conduit and around 90° bends
- Staggered lengths for easier movement
- Keeps pulling head tight for easier movement through conduit

## SPECIFICATIONS

MODEL #	STOCK #	MAXIS GRIPS	GRIPS	WIRE	PULLING JACKET				ROPE SWIVEL	CARRYING BAG	DOUBLE LOCKING HEAD
					MED.	LRG.	LRG.	SML.			
GP110	56822701	Complete Set	Complete Set	1/0 - 750MCM	X	X	X	X	X	---	
GP00AA	56822801	Group AA	4 Grips	1/0 - 4/0						---	
GP101A	56822901	Group A	4 Grips	3/0 - 4/0				X	X	X	
GP102B	56823001	Group B	4 Grips	250 - 350MCM	X			X	X	X	
GP103C	56823101	Group C	4 Grips	400 - 500MCM		X	X		X	X	
GP104D	56823201	Group D	4 Grips	600 - 750MCM		X	X		X	X	



# CABLE PULLING

## SIMpull HEAD® PULLING DEVICE



Available in sizes from 8 AWG to 1000 KCMIL the SIMpull Head® pulling device eliminates the need to make up a pulling head on the job site and reduces waste.

- Factory and Field installable pulling grip
- Eliminates the need to make up a pulling head on the job site and reduces waste
- Low profile head eliminates the problem of the head not fitting in the conduit or around a tight turn
- Patented gripping system — factory installed conductors guaranteed not to pull loose during your pull
- available in 6", 12", 18", 24", and 30" lanyard lengths

## SPECIFICATIONS

DESCRIPTION	AVAILABLE IN
8 AWG SIMpull Head® Pulling Device	Available in 6", 12", 18", 24", & 30" staggered lengths
6 AWG SIMpull Head® Pulling Device	Available in 6", 12", 18", 24", & 30" staggered lengths
4 AWG SIMpull Head® Pulling Device	Available in 6", 12", 18", 24", & 30" staggered lengths
3 AWG SIMpull Head® Pulling Device	Available in 6", 12", 18", 24", & 30" staggered lengths
2 AWG SIMpull Head® Pulling Device	Available in 6", 12", 18", 24", & 30" staggered lengths
1 AWG SIMpull Head® Pulling Device	Available in 6", 12", 18", 24", & 30" staggered lengths
1/0 AWG SIMpull Head® Pulling Device	Available in 6", 12", 18", 24", & 30" staggered lengths
2/0 AWG SIMpull Head® Pulling Device	Available in 6", 12", 18", 24", & 30" staggered lengths
3/0 AWG SIMpull Head® Pulling Device	Available in 6", 12", 18", 24", & 30" staggered lengths
4/0 AWG SIMpull Head® Pulling Device	Available in 6", 12", 18", 24", & 30" staggered lengths
250 KCMIL SIMpull Head® Pulling Device	Available in 6", 12", 18", 24", & 30" staggered lengths
300 KCMIL SIMpull Head® Pulling Device	Available in 6", 12", 18", 24", & 30" staggered lengths
350 KCMIL SIMpull Head® Pulling Device	Available in 6", 12", 18", 24", & 30" staggered lengths
400 KCMIL SIMpull Head® Pulling Device	Available in 6", 12", 18", 24", & 30" staggered lengths
500 KCMIL SIMpull Head® Pulling Device	Available in 6", 12", 18", 24", & 30" staggered lengths
600 KCMIL SIMpull Head® Pulling Device	Available in 6", 12", 18", 24", & 30" staggered lengths
700 KCMIL SIMpull Head® Pulling Device	Available in 6", 12", 18", 24", & 30" staggered lengths
750 KCMIL SIMpull Head® Pulling Device	Available in 9", 15", 21", 27", & 33" staggered lengths
900 KCMIL SIMpull Head® Pulling Device	Available in 9", 15", 21", 27", & 33" staggered lengths
1000 KCMIL SIMpull Head® Pulling Device	Available in 9", 15", 21", 27", & 33" staggered lengths

\*Individual SIMpull Head® Pulling Device model #'s begins with SPH.  
Visit [www.southwire.com](http://www.southwire.com) for full product listing.

# CABLE PULLING

## BASKET GRIPS



Southwire's basket grips will save you time by eliminating cutting, stripping or weaving to make your own pulling head. It features a durable galvanized weather-resistant steel mesh that will not corrode and comes in a variety of sizes to fit your application.

- Flexible/low-profile
- Reusable/durable
- Galvanized for corrosion/weather resistance

MODEL #	UPC	STOCK #	DESCRIPTION	WORKING LOAD LBS.	CABLE DIAMETER RANGER
JBG-024	0-32886-69795-1	65017301	Junior Basket Grip 0.19" - 0.24"	Max Rated Capacity: 80 lb.	0.19" - 0.24"
JBG-036	0-32886-69796-8	65017401	Junior Basket Grip 0.25" - 0.36"	Max Rated Capacity: 90 lb.	0.25" - 0.36"
JBG-049	0-32886-69797-5	65017501	Junior Basket Grip 0.37" - 0.49"	Max Rated Capacity: 180 lb.	0.37" - 0.49"
JBG-061	0-32886-69798-2	65017701	Junior Basket Grip 0.50" - 0.61"	Max Rated Capacity: 260 lb.	0.50" - 0.61"
JBG-074	0-32886-69799-9	65017801	Junior Basket Grip 0.62" - 0.74"	Max Rated Capacity: 390 lb.	0.62" - 0.74"
JBG-099	0-32886-69800-2	65017901	Junior Basket Grip 0.75" - 0.99"	Max Rated Capacity: 560 lb.	0.75" - 0.99"
JBG-124	0-32886-69801-9	65018001	Junior Basket Grip 1.00" - 1.24"	Max Rated Capacity: 780 lb.	1.00" - 1.24"
LBG-061	0-32886-69802-6	65018101	Light Duty Basket Grip 0.50" - 0.61"	Max Rated Capacity: 560 lb.	0.50" - 0.61"
LBG-074	0-32886-69803-3	65018201	Light Duty Basket Grip 0.62" - 0.74"	Max Rated Capacity: 560 lb.	0.62" - 0.74"
LBG-099	0-32886-69804-0	65018301	Light Duty Basket Grip 0.75" - 0.99"	Max Rated Capacity: 800 lb.	0.75" - 0.99"
LBG-124	0-32886-69805-7	65018501	Light Duty Basket Grip 1.00" - 1.24"	Max Rated Capacity: 1360 lb.	1.00" - 1.24"
LBG-149	0-32886-69806-4	65018601	Light Duty Basket Grip 1.25" - 1.49"	Max Rated Capacity: 1360 lb.	1.25" - 1.49"
LBG-199	0-32886-69807-1	65018701	Light Duty Basket Grip 1.50" - 1.99"	Max Rated Capacity: 1360 lb.	1.50" - 1.99"
LBG-249	0-32886-69808-8	65018801	Light Duty Basket Grip 2.00" - 2.49"	Max Rated Capacity: 1700 lb.	2.00" - 2.49"
LBG-299	0-32886-69809-5	65018901	Light Duty Basket Grip 2.50" - 2.99"	Max Rated Capacity: 2120 lb.	2.50" - 2.99"
LBG-399	0-32886-69811-8	65019101	Light Duty Basket Grip 3.5" - 3.99"	Max Rated Capacity: 2940 lb.	3.5" - 3.99"
SHBG-061	0-32886-69812-5	65019301	Short Basket Grip 0.50" - 0.61"	Max Rated Capacity: 900 lb.	0.50" - 0.61"
SHBG-074	0-32886-69813-2	65019401	Short Basket Grip 0.62" - 0.74"	Max Rated Capacity: 1120 lb.	0.62" - 0.74"
SHBG-099	0-32886-69814-9	65019501	Short Basket Grip 0.75" - 0.99"	Max Rated Capacity: 1360 lb.	0.75" - 0.99"
SHBG-149	0-32886-69815-6	65019601	Short Basket Grip 1.00" - 1.49"	Max Rated Capacity: 1920 lb.	1.00" - 1.49"
SHBG-199	0-32886-69816-3	65019701	Short Basket Grip 1.50" - 1.99"	Max Rated Capacity: 3280 lb.	1.50" - 1.99"
SHBG-249	0-32886-69817-0	65019801	Short Basket Grip 2.00" - 2.49"	Max Rated Capacity: 3700 lb.	2.00" - 2.49"
SHBG-299	0-32886-69818-7	65019901	Short Basket Grip 2.50" - 2.99"	Max Rated Capacity: 4900 lb.	2.50" - 2.99"
SHBG-349	0-32886-69819-4	65020101	Short Basket Grip 3.00" - 3.49"	Max Rated Capacity: 4900 lb.	3.00" - 3.49"
SHBG-399	0-32886-69820-0	65020201	Short Basket Grip 3.50" - 3.99"	Max Rated Capacity: 6200 lb.	3.50" - 3.99"
STBG-099	0-32886-69821-7	65020301	Standard Basket Grip 0.75" - 0.99"	Max Rated Capacity: 1360 lb.	0.75" - 0.99"
STBG-149	0-32886-69822-4	65020401	Standard Basket Grip 1.00" - 1.49"	Max Rated Capacity: 1920 lb.	1.00" - 1.49"
STBG-199	0-32886-69823-1	65020501	Standard Basket Grip 1.50" - 1.99"	Max Rated Capacity: 3280 lb.	1.50" - 1.99"
STBG-249	0-32886-69824-8	65020601	Standard Basket Grip 2.00" - 2.49"	Max Rated Capacity: 3700 lb.	2.00" - 2.49"
STBG-299	0-32886-69825-5	65020701	Standard Basket Grip 2.50" - 2.99"	Max Rated Capacity: 4900 lb.	2.50" - 2.99"
STBG-349	0-32886-69826-2	65020801	Standard Basket Grip 3.00" - 3.49"	Max Rated Capacity: 4900 lb.	3.00" - 3.49"

# CABLE PULLING

## BASKET GRIPS CONTINUED

MODEL #	UPC	STOCK #	DESCRIPTION	WORKING LOAD LBS.	CABLE DIAMETER RANGER
STBG-399	0-32886-69827-9	65020901	Standard Basket Grip 3.50" - 3.99"	Max Rated Capacity: 6200 lb.	3.50" - 3.99"
KBG-061	0-32886-69828-6	65021001	K- Basket Grip 0.50" - 0.61"	Max Rated Capacity: 1120 lb.	0.50" - 0.61"
KBG-099	0-32886-69830-9	65021201	K- Basket Grip 0.75" - 0.99"	Max Rated Capacity: 1920 lb.	0.75" - 0.99"
KBG-149	0-32886-69831-6	65021301	K- Basket Grip 1.00" - 1.49"	Max Rated Capacity: 3280 lb.	1.00" - 1.49"
KBG-199	0-32886-69832-3	65021401	K- Basket Grip 1.50" - 1.99"	Max Rated Capacity: 3280 lb.	1.50" - 1.99"
KBG-249	0-32886-69833-0	65021501	K- Basket Grip 2.00" - 2.49"	Max Rated Capacity: 5440 lb.	2.00" - 2.49"
KBG-299	0-32886-69834-7	65021601	K- Basket Grip 2.50" - 2.99"	Max Rated Capacity: 6600 lb.	2.50" - 2.99"
KBG-349	0-32886-69835-4	65021701	K- Basket Grip 3.00" - 3.49"	Max Rated Capacity: 8200 lb.	3.00" - 3.49"
KBG-399	0-32886-69836-1	65021901	K- Basket Grip 3.50" - 3.99"	Max Rated Capacity: 9600 lb.	3.50" - 3.99"
KBG-449	0-32886-69837-8	65022001	K- Basket Grip 4.00" - 4.49"	Max Rated Capacity: 9600 lb.	4.00" - 4.49"
KBG-499	0-32886-69838-5	65022101	K- Basket Grip 4.50" - 4.99"	Max Rated Capacity: 9600 lb.	4.50" - 4.99"
KBG-599	0-32886-69839-2	65022201	K- Basket Grip 5.00" - 5.99"	Max Rated Capacity: 9600 lb.	5.00" - 5.99"
SMBG-061	0-32886-69851-4	65023601	Split Mesh Basket Grip 0.50" - 0.61"	Max Rated Capacity: 300 lb.	0.50" - 0.61"
SMBG-074	0-32886-69852-1	65023701	Split Mesh Basket Grip 0.62" - 0.74"	Max Rated Capacity: 360 lb.	0.62" - 0.74"
SMBG-099	0-32886-69853-8	65023801	Split Mesh Basket Grip 0.75" - 0.99"	Max Rated Capacity: 440 lb.	0.75" - 0.99"
SMBG-124	0-32886-69854-5	65023901	Split Mesh Basket Grip 1.00" - 1.24"	Max Rated Capacity: 680 lb.	1.00" - 1.24"
SMBG-149	0-32886-69855-2	65024001	Split Mesh Basket Grip 1.25" - 1.49"	Max Rated Capacity: 900 lb.	1.25" - 1.49"
SMBG-174	0-32886-69856-9	65024101	Split Mesh Basket Grip 1.50" - 1.74"	Max Rated Capacity: 1160 lb.	1.50" - 1.74"
SMBG-199	0-32886-69857-6	65024301	Split Mesh Basket Grip 1.75" - 1.99"	Max Rated Capacity: 1520 lb.	1.75" - 1.99"
SMBG-249	0-32886-69858-3	65024401	Split Mesh Basket Grip 2.00" - 2.49"	Max Rated Capacity: 1800 lb.	2.00" - 2.49"
SMBG-299	0-32886-69859-0	65024501	Split Mesh Basket Grip 2.50" - 2.99"	Max Rated Capacity: 2200 lb.	2.50" - 2.99"
SMBG-349	0-32886-69860-6	65024601	Split Mesh Basket Grip 3.00" - 3.49"	Max Rated Capacity: 2400 lb.	3.00" - 3.49"
SMBG-399	0-32886-69861-3	65024701	Split Mesh Basket Grip 3.50" - 3.99"	Max Rated Capacity: 2400 lb.	3.50" - 3.99"
MBG-049	0-32886-69840-8	65022301	Multi-Strength Basket Grip 0.25" - 0.49"	Max Rated Capacity: 1360 lb.	0.25" - 0.49"
MBG-074	0-32886-69841-5	65022401	Multi-Strength Basket Grip 0.50" - 0.74"	Max Rated Capacity: 2000 lb.	0.50" - 0.74"
MBG-099	0-32886-69842-2	65022501	Multi-Strength Basket Grip 0.75" - 0.99"	Max Rated Capacity: 2880 lb.	0.75" - 0.99"
MBG-124	0-32886-69843-9	65022701	Multi-Strength Basket Grip 1.00" - 1.24"	Max Rated Capacity: 4920 lb.	1.00" - 1.24"
MBG-174	0-32886-69845-3	65022901	Multi-Strength Basket Grip 1.50" - 1.74"	Max Rated Capacity: 6120 lb.	1.50" - 1.74"
MBG-199	0-32886-69846-0	65023001	Multi-Strength Basket Grip 1.75" - 1.99"	Max Rated Capacity: 9600 lb.	1.75" - 1.99"
MBG-249	0-32886-69847-7	65023101	Multi-Strength Basket Grip 2.00" - 2.49"	Max Rated Capacity: 9600 lb.	2.00" - 2.49"
MBG-299	0-32886-69848-4	65023201	Multi-Strength Basket Grip 2.50" - 2.99"	Max Rated Capacity: 9600 lb.	2.50" - 2.99"
MBG-349	0-32886-69849-1	65023301	Multi-Strength Basket Grip 3.00" - 3.49"	Max Rated Capacity: 9600 lb.	3.00" - 3.49"
MBG-399	0-32886-69850-7	65023501	Multi-Strength Basket Grip 3.50" - 3.99"	Max Rated Capacity: 9600 lb.	3.50" - 3.99"

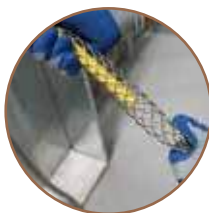
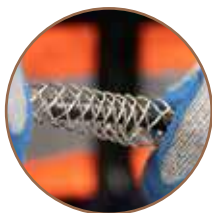

# CABLE PULLING

## PULLING GRIPS



Flexible leader guides steel tapes through conduit and helps reduce the challenge of pulling wire and cable. Available in two separate grip sizes to meet your pulling requirements.

- Used to pull wire and cable through walls and conduit
- Swivel design minimizes cable twisting
- Mesh design holds wire or cable securely during pull
- 100 lb. pulling force capacity
- Available in 1/2" and 3/4" diameters

## SPECIFICATIONS

MODEL #	STOCK #	DESCRIPTION				
WPG3/4	58280801	3/4" Pulling Grip				
WPG1/2	58281001	1/2" Pulling Grip				
	HEIGHT	WIDTH	DEPTH	WEIGHT	DIAMETER	LOAD
WPG3/4	14.25"	0.5"	0.5"	2 oz.	3/4"	100 lb.
WPG1/2	14.25"	0.5"	0.5"	2 oz.	1/2"	100 lb.

# CABLE PULLING

## INDUSTRIAL GRIPit™ PULLING DEVICE



GRIPit™ Circuit management system can help make every branch circuit and home run pull safer, easier, and more productive.

- Reusable pulling head
- No need to strip the wire
- Low-profile head eliminates the problem of the head not fitting in the conduit or around a tight turn
- Easily attach and remove wires without cutting
- Save time making pulling heads
- Usable on solid and stranded wires from sizes 14AWG to 10AWG
- Staggered lengths (6", 12", 18", 24", & 30" lengths available)

## SPECIFICATIONS

MODEL #	STOCK #	DESCRIPTION	LANYARD LENGTH
IG-06	64801501	Industrial GRIPit™ 6" Pulling Device	6" length
IG-12	64801601	Industrial GRIPit™ 12" Pulling Device	12" length
IG-18	64801701	Industrial GRIPit™ 18" Pulling Device	18" length
IG-24	64801801	Industrial GRIPit™ 24" Pulling Device	24" length
IG-30	64801901	Industrial GRIPit™ 30" Pulling Device	30" length
IG-KIT	64802001	Industrial GRIPit™ Pulling Device Kit	Staggered lengths (6", 12", 18", 24", & 30" lengths included)





# CABLE PULLING

## SIMpull™ GRIPit™ CIRCUIT SIZED PULLING HEAD

CSPH1HD



The SIMpull™ GRIPit™ circuit sized pulling head can help make every branch circuit and home run pull safer, easier, and more productive.

- Easily connects to fish tape, string, or rope
- 14 AWG - 10 AWG solid or stranded conductors
- 600 lb. pulling force
- Reusable pulling head for circuit wire
- Easily attach up to 7 wires of 10-14 AWG solid or stranded wires per pulling head
- No cutting, stripping, taping, or weaving wire to make pulling head

### SPECIFICATIONS

MODEL #	STOCK #	DESCRIPTION	
CSPH1HD	58294505	SIMpull™ GRIPit™ Circuit Sized Pulling Head	
WIDTH	DEPTH	WEIGHT	
CSPH1HD	1.5"	0.06"	1.3 oz.



CABLE PULLING | PULLING GRIPS

# CABLE PULLING

## REEL ROLLERS

### RR-SW30



With its heavy-duty, all-welded construction, the Southwire RR-SW30 is built to support up to a 30,000 lb wire reel. With convenient fork tubes and lifting eyes, maneuvering the equipment around the jobsite is easy. You can now safely operate the reel roller by standing outside of the wire's path by remotely operating the unit with the hand controller with variable speed adjustment. When the job is finished and it is time to store the unit, the RR-SW30 will not take up as much room as traditional reel rollers with our new stackability feature. This RR-SW30 can be stacked 4 units high.

- RR-SW30 handles up to 30,000 lb.
- Stackable up to 4 units for the RR-SW30
- Variable speed control
- Hand control for remote operation
- Heavy-duty 10-amp motor
- Convenient fork tubes on both sides
- Made in the USA
- Heavy-duty all welded construction

## SPECIFICATIONS

MODEL #	STOCK #	DESCRIPTION
RR-SW30	65241740	30K Reel Roller



# CABLE PULLING

## SIMpull™ Guidelt™ CIRCUIT ROUTER

WG01



A wire router for circuit panel and junction boxes.

- Universal adapter for hands free circuit wire feeding
- Routes circuit wire in enclosures up to 32"
- Helps to prevent any damage to wire during installation
- Reduces the need to route circuit wire into a raceway or conduit

### SPECIFICATIONS

MODEL #	STOCK #	DESCRIPTION			
WG01	58387301	SIMpull™ Guidelt™ Circuit Router			
	HEIGHT	WIDTH	DEPTH	WEIGHT	
WG01	2.5"	7.5"	23"	2 lb.	

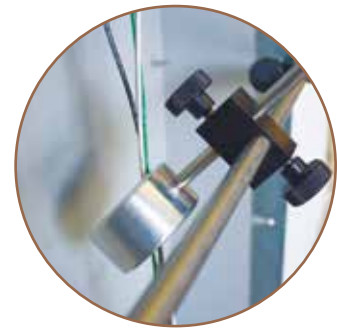
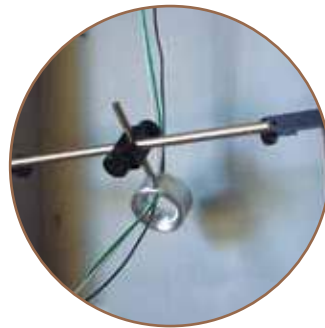

# TERMINATION

---

The Southwire line of termination tools sets a new industry standard. We've revolutionized these tools to make them faster, safer, and smarter than ever before. With Southwire cable stripping, cutting and crimping tools on your job site you can see an increase in safety, efficiency, and profitability.



# TERMINATION

## XT CABLE STRIPPER

**XTS01**  
**XTS01RB**



 **WE'VE GOT IT  
MADE IN AMERICA™**

The XTS-01 cable stripper is made for end and mid-span terminations of 600 volt 1/0 AWG to 1000 KCMIL or outside diameters from .33"-1.284". Works on THHN, XHHW, RHH, RHW, and USE jackets.

- Cutting depth is adjustable to precisely match insulation thickness for fast stripping while eliminating cable scoring
- Adjustable 4" depth gauge provides consistent repeatable strips
- Replaceable, precision razor sharp blade that is safely enclosed within the tool, eliminates stripping cables with a knife
- Capacity : wire 1/0 AWG (.33" in diameter) in size to 1000 KCMIL (approx. 1.284" diameter)

## SPECIFICATIONS

MODEL #	STOCK #	DESCRIPTION		
XTS-01	64984901	XT Cable Stripper		
XTS01-RB	59368901	XTS-01 Cable Stripper Replacement Blade Kit		
	HEIGHT	WIDTH	DEPTH	WEIGHT
XTS-01	8.5"	2.5"	2.25"	1.30 lb.
XTS01-RB	1"	3/8"	3/8"	3gm



TERMINATION | CABLE STRIPPERS



# TERMINATION

## XT MINI STRIPPER

**XTS02**  
**XTS02RB**



**XT Mini stripper for sizes #6 AWG through 1/0 AWG.**

- For end termination on THHN/XHHW 600V insulation types
- Cutting depth is self setting to eliminate cable scoring
- Replaceable blade that is safely enclosed within the housing
- Capacity: Wire sizes #6 AWG through 1/0 AWG

### SPECIFICATIONS

MODEL #	STOCK #	DESCRIPTION	LENGTH	WIDTH	HEIGHT	WEIGHT
XTS02	59894601	XT Mini Stripper	1.2"	1.38"	5"	.38 lb.
XTS02RB	59973501	XT Mini Stripper Replacement Blade Kit	1/2"	1/4"	5/16"	2.34 gm



## XT CABLE STRIPPER COMBO KIT

**XTC100**



**XTC100 Combination stripper kit includes XTS01 and XTS02. Strips wire and cable from #6 AWG-1000 KCMIL.**

### SPECIFICATIONS

MODEL #	STOCK #	DESCRIPTION	LENGTH	WIDTH	HEIGHT	WEIGHT
XTC100	59894501	XT Cable Stripper Combo Kit	10"	10"	3"	2.9 lb.



# CONDUIT BENDING

We don't just help you bend conduit, we change the way you do it. In addition to offering traditional conduit bending tools, Southwire has designed bending platforms that allow you to bend 1/2" to 2" EMT, IMC, and GRC conduit more efficiently, helping you do more work faster.



# CONDUIT BENDING

## BENDMAX™ POWER BENDER

### PB2000



Power bender 3/4" - 2" EMT, IMC, GRC conduit.

- Easily adjustable to ergonomic working height
- Programmable spring back incorporated into digital readout
- Backlit digital display
- 3/4" - 2" EMT, IMC/GRC Conduit Bender
- 2 degree leveling adjustment
- Industrial grade DC drive, and electrical components
- Push cart mounted platform
- Total lock casters
- Large analog protractor for accurate bends
- Remote control pendant with plug-in control cable

## SPECIFICATIONS

MODEL #	STOCK #	DESCRIPTION		
PB2000	59840601	Powered Bender 3/4" - 2" EMT, IMC, GRC Conduit		
DEPTH	WIDTH	HEIGHT	WEIGHT	
PB2000	41"	30"	52"	600 lb.

# CONDUIT BENDING

## MAXIS® MULTI-SHOE BENDER

### MSB2000



 **WE'VE GOT IT  
MADE IN AMERICA™**

The Maxis® Multi-Shoe Bender incorporates multiple shoe groups for a lightweight, highly transportable bender. Bends 1/2"-2" EMT, IMC, and Rigid Conduit

- Muscle Through The Most Demanding Jobs – Ultra-rigid drivetrain optimizes power and efficiency aiding with the most difficult of bends
- Consistent Bending Performance – Precision engineered chassis helps to provide a smooth bending experience
- Resists Wrinkling – Advanced pressure pedal and roller system for wrinkle-free bends on EMT & IMC conduit
- Precision Straight-Track Shoe Mounting – Proprietary shoe mounting design self-aligns & auto-centers the shoe for uniform, clean bends
- Accurate Bending – Large, easy-to-read degree protractor with adjustable pointer arrow for precise bends
- Convenient Storage – Incorporated Operator's Manual Storage canister and an accessible storage pouch for tools and accessories assists with keeping you organized

## SPECIFICATIONS

MODEL #	STOCK #	DESCRIPTION		
MSB2000	66975540	Maxis® Multi-Shoe Bender		
	LENGTH	WIDTH	HEIGHT	WEIGHT
MSB2000	30"	28"	41"	241lb.

MODEL	STOCK	DESCRIPTION
MSB2000I*	66975840	MSB2000I INCLUDES MSB2000 BENDER, IMC SHOE & IMC ROLLER
MSB2000E*	66976140	MSB2000E INCLUDES MSB2000 BENDER, EMT SHOE & EMT ROLLER
MSB2000R*	66976440	MSB2000R INCLUDES MSB2000 BENDER, RIGID SHOE & RIGID ROLLER
MSB-SGRP-IMC	66976740	IMC SHOE GROUP FOR MSB2000 INCLUDES IMC SHOE & ROLLER
MSB-SGRP-EMT	66977040	EMT SHOE GROUP FOR MSB2000 INCLUDES EMT SHOE & ROLLER
MSB-SGRP-RIG	66977340	RIGID SHOE GROUP FOR MSB2000 INCLUDES RIGID SHOE & ROLLER
MSB-SHOE-EMT	66977640	EMT SHOE FOR MSB2000
MSB-SHOE-RIGIMC	66977940	RIGID/IMC SHOE FOR MSB2000
MSB-ROLL-IMC	66978540	ROLLER, IMC, MSB2000
MSB-ROLL-EMT	66978240	ROLLER, EMT, MSB2000
MSB-ROLL-RIG	66978840	ROLLER, RIGID, MSB2000

\*This is a Made-To-Order kit. To see available inventory, look-up the bender and shoe group separately

# CONDUIT BENDING

## BENDMAX™ COMPACT POWER BENDER

**BML2000**



**Compact Power Bender for 3/4" - 2" EMT, IMC, GRC Conduit**

- Bends 3/4" - 2" EMT, IMC/GRC Conduits
- Double sided shoe for EMT and IMC/GRC Conduit
- Large analog protractor for accurate bends
- Push cart mounted platform
- Industrial-grade DC drive and electrical components
- Adjustable squeeze setting for wrinkle-free bends on EMT/IMC conduit
- Durable locking casters
- Fits through finished 30" door frames
- Remote control pendant with plug-in control cable



**WE'VE GOT IT  
MADE IN AMERICA™**

### SPECIFICATIONS

MODEL #	STOCK #	DESCRIPTION	CAPACITY	
BML2000	64601201	BENDMAX™ Compact Power Bender	3/4"-2" EMT, IMC, GRC Conduit	
	HEIGHT	WIDTH	DEPTH	WEIGHT
BML2000	42.94"	27.125"	29.625"	500 lb.





# CONDUIT BENDING

## BENDSTATION™ CONDUIT BENDING WORKSTATION

### RB1000



 **WE'VE GOT IT  
MADE IN AMERICA™**

**BENDSTATION™ Conduit Bending Workstation is faster, more efficient, more accurate, and much easier to use than a hand or Chicago-style bender. It's a mobile workstation that stores all the tools and conduit you need for a full day of bending.**

- Measure, bend, clamp and cut at a comfortable 36" work table height for reduced labor fatigue
- More accurate measurements, bends, and cuts
- Store up to 900 feet of conduit or strut dependent on size
- Extra shelf for storage of tools and materials
- Heavy-duty casters for easy transportation and mobility
- Requires up to 40% less effort than other mechanical benders
- Built-in 60" ruler for quick and accurate measuring
- Eliminates the need to bend over to get a closer look at hand bends
- Unique speed vice designed specifically to hold conduit and unistrut, helps make cutting quicker and safer
- Speeds up the entire bending process up to 30%



## SPECIFICATIONS

MODEL #	STOCK #	DESCRIPTION		
BSCC01	59840701	BENDSTATION™ GRC for 3/4" and 1" GRC and IMC		
RB1000	59840701	BENDSTATION™ for 3/4" and 1" GRC and IMC		
MB1250	64795101	BENDSTATION™ for 1" and 1.25" EMT		
MB1000	64306901	BENDSTATION™ for 3/4" and 1" EMT		
MB750	58315201	BENDSTATION™ for 1/2" and 3/4" EMT		
	LENGTH	WIDTH	HEIGHT	WEIGHT
BSCC01	80"	29"	44"	170 lb.
RB1000	80"	29"	44"	180 lb.
MB1250	80"	29"	44"	185 lb.
MB1000	80"	29"	44"	150 lb.
MB750	80"	29"	44"	132 lb.

MODEL #	STOCK #	DESCRIPTION	CAPACITY	
RBCCH-1000	64316601	Head Kit for 3/4" - 1" GRC and IMC	3/4" - 1" GRC and IMC	
MBCCH-750	64601001	Head Kit for 1/2" - 3/4" EMT	1/2" - 3/4" EMT	
MBCCH-1000	64316701	Head Kit for 3/4" - 1" EMT	3/4" - 1" EMT	
MBCCH-1250	64795301	Head Kit for 1" - 1.25" EMT	1" - 1.25" EMT	
	LENGTH	WIDTH	HEIGHT	WEIGHT
RBCCH-1000	9.20"	17.45"	20.80"	80 lb.
MBCCH-750	7.60"	16.13"	14.87"	32 lb.
MBCCH-1000	8.70"	16.63"	16.61"	49 lb.
MBCCH-1250	10"	12.75"	15.23"	86 lb.

CONDUIT BENDING | BENDERS

# CONDUIT BENDING

## BEND*DOLLY*™ BENDING PLATFORM

**BD1000R**



 **WE'VE GOT IT  
MADE IN AMERICA™**



**Mechanical bending platform.**

- Lightweight bending platform
- Interchangeable shoe mounting plate
- Large dolly wheels for easy maneuverability
- Stable bending platform
- Interchangeable EMT shoes and IMC/GRC shoes
- Durable black powder coating for increased corrosion resistance
- Accepts four different Southwire bending shoes
- Upright storage position

### SPECIFICATIONS

MODEL #	STOCK #	DESCRIPTION	CAPACITY	
BD1000R	64602501	BEND <i>dolly</i> ™ 3/4" - 1" GRC IMC Bender	3/4" - 1" IMC/GRC conduit	
BD-01	64601101	BEND <i>dolly</i> ™ Bending Platform	EMT, IMC/GRC bending shoe sizes 1/2" - 1.25"	
BD750E	64602301	BEND <i>dolly</i> ™ 1/2" - 3/4" EMT Bender	1/2" - 3/4" EMT conduit	
BD1000E	64602401	BEND <i>dolly</i> ™ 3/4" - 1" EMT Bender	3/4" - 1" EMT conduit	
BD1250E	64602401	BEND <i>dolly</i> ™ 1" - 1.25" EMT Bender	1" - 1.25" EMT conduit	
	LENGTH	WIDTH	HEIGHT	WEIGHT
BD1000R	55"	26"	28.75"	140 lb.
BD-01	55"	26"	28.75"	60 lb.
BD750E	55"	26"	28.75"	92 lb.
BD1000E	55"	26"	28.75"	110 lb.
BD1250E	55"	26"	28.75"	145 lb.

### BENDING SHOE HEAD KITS

MODEL #	STOCK #	DESCRIPTION	CAPACITY	
MBCCH-750	64601001	Head Kit for 1/2"-3/4" EMT	1/2"-3/4" EMT	
MBCCH-1000	64316701	Head Kit for 3/4"-1" EMT	3/4"-1" EMT	
MBCCH-1250	64795301	Head Kit for 1"-1.25" EMT	1"-1.25" EMT	
RBCCH-1000	64316601	Head Kit for 3/4"-1" GRC/IMC	3/4"-1" GRC/IMC	
	HEIGHT	WIDTH	DEPTH	WEIGHT
MBCCH-750	14.87"	16.13"	7.60"	32 lb.
MBCCH-1000	16.61"	16.63"	8.70"	49 lb.
MBCCH-1250	15.23"	12.75"	10"	85 lb.
RBCCH-1000	20.80"	17.45"	9.20"	80 lb.

# CONDUIT BENDING

## 1/2" TO 6" PVC MOTORIZED BENDER

### PVCB-06M



6300 watts, 230 VAC, 28 Amp PVC bender.

- Motorized version that rotates PVC conduit at a constant speed for even heating and consistent results
- Durable black powder coating for increased corrosion resistance
- Solid 6" wheels for easy maneuverability
- Chrome-plated reflectors for maximum reflection of infrared energy for a faster bend
- Label includes NEC bending tables
- Bright red indicator light to advise when unit is turned "ON"

### SPECIFICATIONS

MODEL #	STOCK #	DESCRIPTION	DEPTH	WIDTH	HEIGHT	WEIGHT
PVCB-06M	64301301	1/2" to 6" PVC Motorized Bender				
PVCB-06M			11.75"	73"	16.5"	81 lb.

## 1/2" TO 6" PVC BENDER

### PVCB-06



6300 watts, 230 VAC, 28 Amp PVC bender.

- Durable black powder coating for increased corrosion resistance
- Solid 6" wheels for easy maneuverability
- Chrome-plated reflectors for maximum reflection of infrared energy for a faster bend
- Label includes NEC bending tables
- Bright red indicator light to advise when unit is turned "ON"

### SPECIFICATIONS

MODEL #	STOCK #	DESCRIPTION	DEPTH	WIDTH	HEIGHT	WEIGHT
PVCB-06	64301201	1/2" to 6" PVC Bender				
PVCB-06			11.75"	73"	16.5"	80 lb.

# CONDUIT BENDING

## 1/2" TO 4" PVC BENDER

### PVCB-04



2400 watts, 120 VAC, 20 Amp PVC bender.

- Durable black powder coating for increased corrosion resistance
- Solid 6" wheels for easy maneuverability
- Chrome-plated reflectors for maximum reflection of infrared energy for a faster bend
- Label includes NEC bending tables
- Bright red indicator light to advise when unit is turned "ON"

### SPECIFICATIONS

MODEL #	STOCK #	DESCRIPTION	DEPTH	WIDTH	HEIGHT	WEIGHT
PVCB-04	64301101	1/2" to 4" PVC Bender				
PVCB-04			8.5"	56"	13"	50 lb.

## 1/2" TO 2" PVC BENDER

### PVCB-02



1700 watts, 115 VAC, 15 Amp PVC bender.

- Durable black powder coating for increased corrosion resistance
- Chrome-plated reflectors for maximum reflection of infrared energy for a faster bend
- Label includes NEC bending tables
- Bright green indicator light to advise when unit is turned "ON"

### SPECIFICATIONS

MODEL #	STOCK #	DESCRIPTION	DEPTH	WIDTH	HEIGHT	WEIGHT
PVCB-02	64812201	1/2" to 2" PVC Bender				
PVCB-02			32"	10"	11"	19 lb.

# CONDUIT BENDING

## PVC HEATING BLANKET



PVCHB-13, PVCHB-30, PVCHB-38 heating blankets.

- Heats to 300° F
- Wrap blanket around PVC and easily secure with velcro strap
- Make bends, offsets or saddles in PVC
- Compact for easy storage and transport
- Power source: 120 VAC

## SPECIFICATIONS

MODEL #	STOCK #	DESCRIPTION	WORKING LOAD
PVCHB-13	67589540	PVC Heating Blanket 13"	200 WATT
PVCHB-30	67589640	PVC Heating Blanket 30"	800 WATT
PVCHB-38	67589740	PVC Heating Blanket 38"	1300 WATT

### PVCHB13



### PVCHB30



### PVCHB38





# CONDUIT BENDING

## PLUG KITS

**PVCP-01**



Use with Southwire electric PVC benders and PVC heating blankets. Plugs are inserted into the ends of the PVC conduit to prevent the conduit from collapsing during heating.

- Prevents conduit from collapsing when heated
- Plug kits for all Southwire PVC conduit benders and PVC conduit heating blankets
- Rugged carrying case to store and transport plugs
- Durable long lasting neoprene gaskets
- Twist lock design for easy installation and removal
- Provides air tight seal

**PVCP-02**



## SPECIFICATIONS

MODEL #	STOCK #	DESCRIPTION
PVCP-01	643014	2" to 4" Bending Plug Kit
PVCP-02	643016	2" to 6" Bending Plug Kit





# HOLE MAKING

## MAX PUNCH® XD

**MPXD**



Heavy-duty knockout punch driver for stainless and mild steel.

- No hydraulics, no ratcheting, no mess
- Thread-in/thread-out removable drawstuds (universal to fit most common KO dies)
- Rated to cut 10 gauge mild and stainless steel up to 4"
- Minimum drill recommendations: 18V cordless, equivalent of 550 in. lbs. torque rated

### MPXD-SD

INCLUDES:

- MAX PUNCH® XD drive unit
- 1/2" – 2" MAX PUNCH® Pro cutting dies (rated for stainless steel)
- 2 drawstuds sizes 3/4" & 7/16"
- Marksman™ conduit layout tool
- Step drill bit (3/16" – 7/8", 2 nut drivers) (7/16")
- Heavy-duty carrying case

**MPXD-SD**



### MP-03PRO

INCLUDES:

- 2 1/2" - 4" MAX PUNCH® Pro cutting dies
- 1 1/8" drawstud
- Heavy-duty carrying case

**MP-03PRO**



## SPECIFICATIONS

MODEL#	STOCK #	DETAILS		
MPXD	63159701	MAX PUNCH® XD: drive unit only (no case)		
MPXD-SD	63159901	MAX PUNCH® XD w/ stainless steel rated dies - 1/2" - 2" set (1 case)		
MP-03PRO	57177201	MAX PUNCH® PRO STAINLESS STEEL 2 1/2" - 4" SET		
MODEL#	LENGTH	WIDTH	DEPTH	WEIGHT
MPXD	5.5"	11.5"	4.25"	5.5 lb.
MPXD-SD	16.5"	8.5"	13"	14.5 lb.
MP-03PRO	16.5"	13"	5"	22.5 lb.

# HOLE MAKING

## MAX PUNCH™ 360 HYDRAULIC KNOCKOUT TOOL

### MP360HP



Heavy duty 12-ton hydraulic knockout with 360° articulation.

- Full 360° articulating head for tight spaces
- Lightweight aluminum head
- Compact pump with padded handle

### SPECIFICATIONS

MODEL#	STOCK #	DETAILS		
MP360HP	59159001	MAX PUNCH™ 360 DRIVE UNIT ONLY		
MP360SDPRO	58973801	MAX PUNCH™ 360 STAINLESS STEEL 1/2" - 2" SET		
MP-03PRO	57177201	MAX PUNCH™ PRO STAINLESS STEEL SET 2 1/2" - 4" SET		
HPS12	57578301	HPS12 360 HYDRAULIC PUNCH SPACER 1/2"		
MODEL#	LENGTH	WIDTH	DEPTH	WEIGHT
MP360HP	4.5"	5.25"	3.75"	5.5 lb.
MP360SDPRO	21"	12"	4"	15 lb.
MP-03PRO	16.5"	13"	5"	22.5 lb.
HPS12	1.87"	1.87"	0.591	.337 lbs

### HPS12



### MP360SDPRO



### MP-03PRO



# HOLE MAKING

## MAX PUNCH™ HSP HYDRAULIC STUD PUNCH

MPHSP



4 tools in 1 and is adjustable for 3 5/8" and 6" studs, punches 7/8" or 1 11/32" holes.

- Punches holes in 16 gauge structural steel studs
- Compact design fits in tight spaces
- Padded handles provide gripping comfort and greater control
- Heavy-duty carrying case

### SPECIFICATIONS

MODEL #	STOCK #	DESCRIPTION	
MPHSP	58946501	MAX PUNCH™ Hydraulic Stud Punch	
MODEL #	LENGTH	WIDTH	WEIGHT
MPHSP	17.5"	10.5"	11 lb.





# HOLE MAKING

## MAX PUNCH™ MANUAL STUD PUNCH

MSP01



2 tools in 1, punches 7/8" and 1 11/32" holes.

- Sizes include - 7/8" (22.5mm) & 1-11/32" (34.1mm)
- MAX PUNCH™ Manual Stud Punch is intended to punch round holes in 20 gauge steel studs
- Lock to keep handle in place when not in use
- Lightweight punch makes accurate location of holes easier
- Cushioned handle gives more leverage and makes it easier to punch in tight spaces, meaning less operator fatigue and more comfortable handling

### SPECIFICATIONS

MODEL #	STOCK #	DESCRIPTION		
MSP01	57576201	MAX PUNCH™ MANUAL STUD PUNCH		
MODEL #	HEIGHT	WIDTH	LENGTH	WEIGHT
MSP01	2.25"	8.55"	18.5"	7.5 lb.



HOLE MAKING | KNOCKOUTS

# HOLE MAKING

## MAX PUNCH™ RATCHET SET WITH 1/2" - 2" CUTTING DIES

### MPR-01SD



Flex head ratchet wrench allows for easy maneuverability around obstacles.

- Cuts through 12 gauge mild steel as well as aluminum, fiberglass, and plastics
- Unique 3-point cup cutting surface provides a clean, quick, and easy cut for 1" through 2" dies
- Cup design creates crimping effect on slug for easy removal for 1" through 2" dies
- Ball bearing draw stud for reduced friction
- Includes Southwire Marksman® (Model # MM01) Conduit Layout Tool
- Includes 1/2", 3/4", 1", 1 1/4", 1 1/2", and 2" dies

### SPECIFICATIONS

MODEL #	STOCK #	DESCRIPTION	HEIGHT	WIDTH	LENGTH	WEIGHT
MPR-01SD	58289240	MAX PUNCH™ Ratchet Set with 1/2"-2" Dies				
MPR-01SD			14.17"	10.43"	2.76"	11.57 lb.

# HOLE MAKING

## MAX PUNCH® STAINLESS STEEL CUPS & CUTTERS

Stainless steel cups and cutters.



- Unique 3 point cutting surface provides a cleaner, quicker and easier cut for 1" through 4" dies
- Rated for 10 gauge stainless steel (3.5mm) as well as mild steel, aluminum, fiberglass and plastics
- Will not bow panel or leave jagged edges
- Crimping effect on slug for easy removal

MODEL #	STOCK #	DESCRIPTION	CONDUIT & PIPE SIZE	ACTUAL HOLE SIZE (IN)	ACTUAL HOLE SIZE (MM)	CAPACITY S.S. GA
MPK050PRO	57174601	MAX PUNCH® Cutter for Stainless Steel 1/2"	1/2"	.89	23	10
MPC50PRO	57176101	MAX PUNCH® Cup for Stainless Steel 1/2"	1/2"	.89	23	10
MPK075PRO	57174701	MAX PUNCH® Cutter for Stainless Steel 3/4"	3/4"	1.12	28	10
MPC75PRO	57176201	MAX PUNCH® Cup for Stainless Steel 3/4"	3/4"	.12	28	10
MPK0100PRO	57174801	MAX PUNCH® Cutter for Stainless Steel 1"	1"	1.36	35	10
MPC100PRO	57176301	MAX PUNCH® Cup for Stainless Steel 1"	1"	1.36	35	10
MPK0125PRO	57174901	MAX PUNCH® Cutter for Stainless Steel 1 1/4"	1 1/4"	1.70	43	10
MPC125PRO	57176401	MAX PUNCH® Cup for Stainless Steel 1 1/4"	1 1/4"	1.70	43	10
MPK0150PRO	57175001	MAX PUNCH® Cutter for Stainless Steel 1 1/2"	1 1/2"	1.95	50	10
MPC150PRO	57176501	MAX PUNCH® Cup for Stainless Steel 1 1/2"	1 1/2"	1.95	50	10
MPK0200PRO	57175101	MAX PUNCH® Cutter for Stainless Steel 2"	2"	2.42	62	10
MPC200PRO	57176601	MAX PUNCH® Cup for Stainless Steel 2"	2"	2.42	62	10
MPK0250PRO	57175301	MAX PUNCH® Cutter for Stainless Steel 2 1/2"	2 1/2"	2.92	74	10
MPC250PRO	57176701	MAX PUNCH® Cup for Stainless Steel 2 1/2"	2 1/2"	2.92	74	10
MPK0300PRO	57175401	MAX PUNCH® Cutter for Stainless Steel 3"	3"	3.55	90	10
MPC300PRO	57176801	MAX PUNCH® Cup for Stainless Steel 3"	3"	3.55	90	10
MPK0350PRO	57175501	MAX PUNCH® Cutter for Stainless Steel 3 1/2"	3 1/2"	4.04	103	10
MPC350PRO	57176901	MAX PUNCH® Cup for Stainless Steel 3 1/2"	3 1/2"	4.04	103	10
MPK0400PRO	57175601	MAX PUNCH® Cutter for Stainless Steel 4"	4"	4.54	115	10
MPC400PRO	57177001	MAX PUNCH® Cup for Stainless Steel 4"	4"	4.54	115	10
MP-02PRO	57177101	Small Die Set 1/2"-2" in case (drive unit not included)	1/2" - 2"	.89-2.42	23-62	10
MP-03PRO	57177201	MAX PUNCH® PRO STAINLESS STEEL SET 2 1/2" - 4"	2 1/2" - 4"	2.92-4.54	74-115	10

HOLE MAKING | KNOCKOUTS

# HOLE MAKING

## MARKSMAN® CONDUIT LAYOUT TOOL

MM01



A conduit layout tool that will pinpoint a center knockout in seconds. The Marksman® Layout Tool also features a panel schedule showing the branch circuit number and its corresponding phase.

- Easy to use
- Does not require math
- For KO sizes 1/2" to 4"
- Underground and overhead
- The Southwire Marksman® conduit layout tool is constructed of tough durable anodized aluminum
- Markings are etched for maximum durability

### SPECIFICATIONS

MODEL #	STOCK #	DESCRIPTION			
MM01	58281940	Marksman Conduit Layout Tool			
	HEIGHT	WIDTH	DEPTH	WEIGHT	KNOCKOUT SIZES
MM01	6.5"	2"	0.25"	2.5 oz.	1/2" - 4"

# HOLE MAKING

## DRAW STUDS FOR MAX PUNCH® DRIVE UNITS

### XDDS34



### PRDS716



### PRDS118



### MPDS12



### MAX PUNCH® PRO DRAW STUDS

- 3/4" - Main Draw Stud - Stock #64864001 Model #XDDS34
- 7/16" - Medium Draw Stud - Stock #57717901 Model #PRDS716
- 1 1/8" - Large Draw Stud (for 2 1/2" – 4" MAX PUNCH® and MAX PUNCH® PRO Dies) Stock #58306101 Model #PRDS118

### MAX PUNCH® DRAW STUDS

- 3/4" - Main Draw Stud - Stock #56825901 Model #MPDS12

## SPECIFICATIONS

MODEL#	STOCK #	DESCRIPTION	LENGTH	WEIGHT	DIAMETER
XDDS34	64864001	3/4" MAIN DRAW STUD MAX PUNCH® PRO	5"	8.7 oz.	3/4"
PRDS716	57717901	7/16" MEDIUM DRAW STUD - MAX PUNCH® PRO	4.25"	4.6 oz.	7/16" - 3/4"
PRDS118	58306101	LARGE DRAW STUD - 1 1/8" (FOR MILD STEEL OR STAINLESS STEEL LARGE DIES)	4.4"	15.6 oz.	1 1/8"
MPDS12	56825901	1/2" MAIN DRAW STUD - MAX PUNCH®	11.5"	4.4 oz.	15/16"



# HOLE MAKING

## BI-METAL HOLE SAWS

### BMHSKIT9



These bi-metal hole saws are heavy duty and allow for fast cutting of steel, aluminum, brass, wood, plastic, and drywall.

- Increased plug ejection slots for easy removal of cutting materials
- Larger hole saw depth limits blocked ejection slots
- Custom steel body and M42 teeth for improved performance
- Lifetime tooth breakage warranty

### SPECIFICATIONS

MODEL #	STOCK #	DESCRIPTION
BMHSKIT9	58297640	9-Piece Bi-Metal Hole Saw Kit
BMHS4-3/8	64278140	Bi-Metal Hole Saw 4-3/8" (111mm) (4" Recessed Lights)
BMHS5-3/8	64278240	Bi-Metal Hole Saw 5-3/8" (137mm) (5" Recessed Lights)
BMHS6-3/8	58297540	Bi-Metal Hole Saw 6-3/8" (162mm) (6" Recessed Lights)
ABS1/2	58295340	Large Quick Connect Arbor
MODEL #	STOCK #	INCLUDES
BHMSKIT9	58297640	(6) Bi-metal hole saws: 7/8", 1-1/8", 1-3/8", 1-3/4", 2", 2-1/2", (1) 3/8" hex shank mandrel, (1) 3/8" qck. chg. mandrel, (2) pilot bits
BMHS4-3/8	64278140	(1) 4-3/8" Hole Saw
BMHS5-3/8	64278240	(1) 5-3/8" Hole Saw
BMHS6-3/8	58297540	(1) 6-3/8" Hole Saw
ABS1/2	58295340	(1) 1/2" Arbor bit shank

## ADJUSTABLE CAN LIGHT HOLE SAW

### ACLHS



Adjustable hole saw featuring black oxide blades cleanly and efficiently cuts precise holes in drywall and ceiling tiles.

- 19 blade adjustment positions ranging from 2-1/2" to 7"
- 1/4" increments
- Black oxide blades cut cleanly through drywall and ceiling tiles
- Hex key adjustment allows for easy movement of blade
- Includes two dust shields

### SPECIFICATIONS

MODEL #	STOCK #	DESCRIPTION		
ACLHS	59705440	Adjustable Can Light Hole Saw		
		HEIGHT	WIDTH	WEIGHT
ACLHS		2.17"	8.27"	2.08 lb.

# HOLE MAKING

## FLEX AUGER BITS

**FAB9/16X54**



**FAB3/8X54**



**FAB1X54**



**FAB3/4X54**



54" flex auger bits with screw point tips easily drill clean holes through wood inside walls.

- Pilot feed-screw draws bit into wood
- Spring steel shaft resists deformation
- Hole in tip for use with wire and cable pulling grips

## SPECIFICATIONS

MODEL #	STOCK #	DESCRIPTION
FABK9/16X54	58297740	9/16" Flex Bit Kit
FAB9/16X54	58296940	9/16" Flex Bit
FAB3/8X54	58296840	3/8" Flex Bit
FAB3/4X54	58296740	3/4" Flex Bit
FAB1x54	58297040	1" Flex Bit
MODEL #	STOCK #	INCLUDES
FABK9/16X54	58297740	(1) 9/16" X 54" Flex Bit, (1) Cable Pulling Grip, (1) Folding Placement Tool
FAB3/8X54	58296840	(1) 3/8" Flex Bit
FAB9/16X54	58296940	(1) 9/16" Flex Bit
FAB3/4X54	58296740	(1) 3/4" Flex Bit
FAB1x54	58297040	(1) 1" Flex Bit

# HOLE MAKING

## FLEXIBLE QUICK CONNECT EXTENSION KIT

**FQCKIT**



Perfect for installing wire in existing walls and ceilings.

- Kit includes everything needed to drill and pull light to medium wire
- Multiple extensions can be joined for increased versatility
- Convenient 1/4" quick connect receivers
- Auger bit with self-feeding screw tip draws bit through wood
- Quick connect accepts bits up to 3/4" in diameter
- Includes:
  - (1) 1/2" O.D. pulling grip
  - (1) 18" Flexible Quick Connect Extension
  - (1) 36" Flexible Quick Connect Extension
  - (1) 3/4" x 4-1/2" auger bit

### SPECIFICATIONS

MODEL #	STOCK #	DESCRIPTION	INCLUDES		
FQCKIT	59705040	Flexible Quick Connect Extension Kit	(1) 1/2" O.D. pulling grip, (1) 18" Flexible Quick Connect Extension, (1) 36" Flexible Quick Connect Extension, and (1) 3/4" x 4-1/2" auger bit		
		HEIGHT	WIDTH	DEPTH	WEIGHT
FQCKIT		59.5" Assembled	3/4" (max bit width)	1"	0.66 lb.

## FLEXIBLE QUICK CONNECT EXTENSION

**FQCE36**



36" flexible quick change extension is perfect for installing wire in existing walls and ceilings.

- Flexible shaft allows easy access to difficult and confined areas
- Quick connect accepts bits up to 3/4" in diameter
- Multiple extensions can be joined for increased versatility
- Convenient 1/4" quick connect receivers

### SPECIFICATIONS

MODEL #	STOCK #	DESCRIPTION			
FQCE36	59704940	Flexible Quick Connect Extension			
		HEIGHT	WIDTH	DEPTH	WEIGHT
FQCE36		36"	1/4" (shank)	0.86"	0.33 lb.

# HOLE MAKING

## SHIP AUGER BITS

### SAB3/4X18



Heavy-duty ship auger bit, featuring a self-feeding screw tip, drills clean holes through nails, wood, vinyl, plastic, and heavy timber.

- Screw tip draws bit through wood
- Polished and coated flutes increase removal of cutting material
- 18" length allows deep drilling without an extension

### SAB7/8X18



### SAB1X18



## SPECIFICATIONS

MODEL #	STOCK #	DESCRIPTION
SAB3/4x18	58295540	3/4" Ship Auger Bit
SAB7/8x18	58295640	7/8" Ship Auger Bit
SAB1x18	58295440	1" Ship Auger Bit
MODEL #	STOCK #	
SAB3/4x18	58295540	---
SAB7/8x18	58295640	---
SAB1x18	58295440	---

## WOOD BORING BITS

### WAB3/4X4-1/2



Heavy-duty, self-feeding wood boring bits cut clean holes in wood.

- Screw tip draws bit through wood
- Polished and coated flutes increase removal of cutting material
- 4.5" length for drilling in tight spaces

### WAB7/8X4-1/2



### WAB1X4-1/2



## SPECIFICATIONS

MODEL #	STOCK #	DESCRIPTION
WAB3/4X4-1/2	58296040	3/4" Wood Auger Bit
WAB7/8X4-1/2	58296140	7/8" Wood Auger Bit
WAB1X4-1/2	58295940	1" Wood Auger Bit
MODEL #	STOCK #	INCLUDES
WAB3/4X4-1/2	58296040	(1) Wood Auger Bit
WAB7/8X4-1/2	58296140	(1) Wood Auger Bit
WAB1X4-1/2	58295940	(1) Wood Auger Bit

# HOLE MAKING

## DRILL / TAP BITS



Our drill/tap bits feature a one-piece drill and tap design that saves time by drilling, tapping, countersinking, and deburring in one smooth operation.

- Made of high-speed steel for durability
- Tapered design prevents thread damage
- For use with steel, copper, brass, aluminum, and plastic

## SPECIFICATIONS

MODEL #	STOCK #	DESCRIPTION
CDTBKIT	58296340	Combination Drill and Tap Set
MODEL #	STOCK #	INCLUDES
CDTBKIT	58296340	(6) Drill/Tap Bits: 6-32 NC, 8-32 NC, 10-24 NC, 10-32 NC, 12-24 NC, 1/4-20 NC, (1) Quick Change Adapter

## STEP DRILL BITS

**SB3/16-7/8**



Step drill bits for clean hole drilling in metals.

- Laser-etched sizes for easy identification
- Tri-lobe shank reduced reduces slipping and provides a firm grip in the chuck
- Double flute design for a true, round hole every time

**SB1/4-1-3/8**



## SPECIFICATIONS

MODEL #	STOCK #	DESCRIPTION
SB3/16-7/8	58297440	3/16"-7/8" Step Drill Bit
SB1/4-1-3/8	58297240	1/4"- 1-3/8" Step Drill Bit
MODEL #	STOCK #	INCLUDES
SB3/16-7/8	58297440	(1) Step Drill Bit
SB1/4-1-3/8	58297240	(1) Step Drill Bit



# HOLE MAKING

## CARBIDE TIPPED HOLE CUTTERS



The carbide tipped hole cutters have a durable cutting design specifically for stainless steel and sheet metal.

- Precision ground teeth for fast cutting of clean, round holes
- Double helix grooves for faster starts
- Grooved edge design to prevent extended penetration

### SPECIFICATIONS

MODEL #	STOCK #	DESCRIPTION
CHCKIT4	58295140	Carbide Tipped Hole Cutter Kit
CHC7/8	58295040	7/8" Carbide Tipped Hole Cutter
CHC1-1/8	58294940	1-1/8" Carbide Tipped Hole Cutter
CHC1-3/8	64606940	1-3/8" Carbide Tipped Hole Cutter
MODEL #	STOCK #	INCLUDES
CHCKIT4	58295140	(3) Carbide Tipped Hole Cutters: 7/8", 1-1/8", 1-3/8"; (4) Pilot drill bits; (1) Allen wrench
CHC7/8	58295040	(1) 7/8" Carbide tipped hole cutter: For use with 1/2" fittings
CHC1-1/8	58294940	(1) 1-1/8" Carbide tipped hole cutter: For use with 3/4" fittings
CHC1-3/8	64606940	(1) 1-3/8" Carbide tipped hole cutter: For use with 1" fittings

# MATERIAL HANDLING

---

As one of the most innovative tool lines in the industry, Southwire Tools and Equipment has provided material handling solutions that move material quickly, easily, and safely. With a product line that includes reel jacks, SIMpull™ CoiPAK™ carts, and Wire Wagon® carts, you can complete the job better than ever before while saving both time and energy.



# MATERIAL HANDLING

## SIMpull™ FLANGE

SF-01



The SIMpull™ Flange's patented shaftless design, safely allows one person to turn a wooden or plastic reel up to 34 in. and 2,000 lb. into a time saving, field-installable solution that removes the need to handle heavy jack stands. Each flange rotates independently, and allows free movement of loaded wooden or plastic reels. The SIMpull™ Flange is reusable in the field and can be installed on multiple reels throughout the jobsite.

U.S. PATENT #: US9617112

### SPECIFICATIONS

MODEL #	STOCK #	DESCRIPTION
SF-01	64864901	SIMpull™ FLANGE



MATERIAL HANDLING | FLANGE

# MATERIAL HANDLING

## PROJAX™ REEL STANDS

MPJ01  
MPJ02



A 10,000 lb. capacity portable reel stand.

- One person can easily transport through most jobsite environments
- PROJAX™ stands can lift up to 10,000 lb. as a pair (4545 kg)
- Easy adjustment for uneven surfaces on jobsite
- Axle rests on steel rollers for easy wire payoff
- Axle safety guard ensures that reel will not fall off of jack stands
- Uses an 18V cordless drill to lift wire reels
- Minimum drill recommendations: 18V cordless, equivalent of 1000 in. lb. torque rated, for reels up to 10,000 lb.
- Can be used with 1 1/4" - 3" axle
- Includes axle storage assembly



WE'VE GOT IT  
**MADE IN AMERICA™**

## SPECIFICATIONS

MODEL #	STOCK #	DESCRIPTION	LENGTH	WIDTH	HEIGHT	WEIGHT
MPJ01	58133201	PROJAX™ Reel Stands (Single)				
MPJ02	58526401	PROJAX™ Reel Stands (Pair)				
MPJ01 (single)	41"	17"	43"	118 lb.		





# MATERIAL HANDLING

## QWIKJAX™ REEL STANDS

QJ-01



QWIKJAX™ 3,000 lb. collapsible reel stand (Single)

- 6,000 lb. capacity per pair (2727 kg)
- One person can easily transport through most jobsite environments
- Axle safety catch hook ensures that reel will not fall off of jack stands
- Axle rests on steel rollers for easy wire pay off
- Maximum reel height: up to 72" reel
- Quick folding feature for compact storage
- Sliding cradle for quick adjustments on large reels
- Easy-to-use, one person setup and operation
- Easy adjustment for uneven surfaces on jobsites

### SPECIFICATIONS

MODEL #	STOCK #	DESCRIPTION		
QJ-01	64237801	QWIKJAX™ Portable Reel Stand (Single)		
DEPTH	WIDTH	HEIGHT	WEIGHT	
QJ-01	29"	17"	29" - 42"	35 lb.



MATERIAL HANDLING | REEL STANDS



# MATERIAL HANDLING

## MAXISJAX® REEL STANDS

### MJ707



A unique reel stand that will quickly set up and lift wire reels safely and efficiently without the hassle of conventional stands.

- Easy to store and transport
- Breaks down into a compact storable tool
- Jaw clamps onto axle so that wire reels won't come off or fall over
- Multiple steel rollers make it easy for one person to roll off heavy wire
- Max lever allows one person to lift wire reels off the ground with minimal effort
- Uses either a 1-1/2" to 2" rigid pipe for an axle
- Each pair lifts wire reels up to 3,000 lb. and reels up to 48" tall

## SPECIFICATIONS

MODEL #	STOCK #	DESCRIPTION		
MJ707	56824501	MAXISJAX® - 3,000 lb. Reel Stands (Pair)		
	HEIGHT	WIDTH	LENGTH	WEIGHT
MJ707	37"	7"	9.5"	54 lb.



# MATERIAL HANDLING

## REEL MAC™

CJ01  
CJ02  
CJ03



The Sumner Reel Mac™ jack stands are a heavy-duty version of the traditional reel stand with capacity up to 3,750 lbs.

- Designed for large loads up to 3,750 lbs. depending on reel stand
- Height range of 13" - 45" depending on reel stand
- Extra strength double locking pin for quick set up
- 1.5" ACME fine adjustment thread with large, convenient adjustment handle
- Designed to work with the Sumner Reel/Econo Mac Spindles

MODEL #	STOCK #	DESCRIPTION	LOAD CAPACITY
CJ02	780941	Reel Mac™ No. 60	2500 lb.
CJ01	780942	Reel Mac™ No. 70	2500 lb.
CJ03	780943	Reel Mac™ No. 80	3750 lb.
OPTIONAL REEL MAC™ ACCESSORIES			
SA60	780229	No. 61 Reel Mac™ Spindle (62")	5000 lb.
SA70	780230	No. 71 Reel Mac™ Spindle (76")	5000 lb.

MATERIAL HANDLING | REEL STANDS

# MATERIAL HANDLING

## PROJAX™ AXLES

### PJA-01



### PJA-02



### PROJAX™ AXLES

- Heavy duty 10,000 lb. capacity
- Low deflection high strength steel
- Available in 60" and 72" lengths

## SPECIFICATIONS

MODEL #	STOCK #	DESCRIPTION
PJA-01	58948701	10,000 lb. capacity 72" reel axle
PJA-02	59161901	10,000 lb. capacity 60" reel axle

## PROJAX™ RISERS

### PJS-01



### PROJAX™ RISERS

- Enables PROJAX™ reel stands to be used with 104" reels

## SPECIFICATIONS

MODEL #	STOCK #	DESCRIPTION
PJS-01	58955301	Riser attachment for PROJAX™ reel stands (Pair)

# MATERIAL HANDLING

## PALLET JACKS



**779765**



**779766**

The Sumner low profile 20" or 27" pallet jack will handle heavy lifting for you with its 2.5" low profile fork height allowing for easy engagement of most pallets.

- 6,600 lbs. weight capacity
- Three-function handle controls raising, lowering, and neutral
- Welded all-steel frame and tough powder coat finish provides maximum durability and protection
- Minimum fork height of 2.5"
- Maximum lift height of 6.25"
- 180° turning radius
- 2.5" inch low profile allows for easy engagement of pallets

## SPECIFICATIONS

MODEL #	STOCK #	DESCRIPTION	LOAD CAPACITY
PJ27	779765	27" x 48" Pallet Jack	6,600 lb.
PJ20	779766	20" x 48" Pallet Jack	6,600 lb.

# MATERIAL HANDLING

## SIMpull™ CoilPAK™ CART

CK01



 WE'VE GOT IT  
MADE IN AMERICA™

The best material handling solution for SIMpull™ CoilPAK™ Payoffs.

- Rugged transport system for (8) SIMpull™ CoilPAK™ Payoffs with an integrated pay off system
- Allows SIMpull™ CoilPAK™ Wire Payoffs to be added or changed easily without impacting other SIMpull™ CoilPAK™ Wire Payoffs
- Innovative staging springs allow you to secure and organize up to 8 wires
- Best for scenarios where conductors are frequently changing, adding or dropping
- Cart includes 8" total lock casters
- Easy to use in hallways and fits through standard doors
- Individual wire feeds similar to a wire cart

### SPECIFICATIONS

MODEL #	STOCK #	DESCRIPTION			
CK01	58386901	SIMpull™ CoilPAK™ CART			
		LENGTH	WIDTH	HEIGHT	WEIGHT
CK01		52"	24"	90"	178 lb.

## SIMpull™ CoilPAK™ UTILITY CART

UC100



 WE'VE GOT IT  
MADE IN AMERICA™

Multipurpose cart designed for SIMpull™ CoilPAK™ solutions.

- Can hold and transport a verity of materials, tools, supplies, and SIMpull™ CoilPAK™ Payoffs
- Ability to hold up to 8 SIMpull™ CoilPAK™ Payoffs
- Incorporated low payoff height for easy circuit wire pulling at any angle
- Compact cart design for easy storage and transport
- Cart includes 8" total lock casters

### SPECIFICATIONS

MODEL #	STOCK #	DESCRIPTION			
UC100	58617201	SIMpull™ CoilPAK™ UTILITY CART			
		LENGTH	WIDTH	HEIGHT	WEIGHT
UC100		46"	24"	45"	107 lb.



# MATERIAL HANDLING

## SIMpull™ BARREL™ HAND TRUCK



The SIMpull™ BARREL™ Hand Truck makes it easy to handle and transport your SIMpull™ BARREL™ Drum.

- The SIMpull™ BARREL™ Hand Truck, when used with the SIMpull™ BARREL™ package, replaces the old wire cart and reels and the issues associated with them
- The hand truck includes a wire payoff feature, and is designed to transport the SIMpull™ BARREL™ package anywhere on the jobsite - through narrow electrical room doors, over cords on the floor or construction gravel
- Solid rubber tires for no-flat jobsite peace of mind
- Rugged steel frame with unique design

### SPECIFICATIONS

MODEL #	STOCK #	DESCRIPTION	LENGTH	WIDTH	HEIGHT	WEIGHT
SBT01	58133001	SIMpull™ BARREL™ HAND TRUCK				
SBT01			27"	24.5"	61"	145 lb.

 WE'VE GOT IT  
**MADE IN AMERICA™**

## SIMpull™ BARREL™ TRIPOD



The SIMpull™ BARREL™ Tripod is a circuit wire payoff accessory used in connection with your SIMpull™ BARREL™ Drum.

- The SIMpull™ BARREL™ Tripod is a circuit wire guide that mounts easily on the rim of the SIMpull™ BARREL™
- This wire guide system provides unique means for guiding the paralleled conductors out of the barrel when it is not on the SIMpull™ BARREL™ Hand Truck

### SPECIFICATIONS

MODEL #	STOCK #	DESCRIPTION	LENGTH	WIDTH	HEIGHT	WEIGHT	TAP OUTSIDE DIAMETER
SBT02	58133101	SIMpull™ BARREL™ TRIPOD					
SBT02			36.5"	6.25"	6.25"	5.5 lb.	4.98"

 WE'VE GOT IT  
**MADE IN AMERICA™**

# MATERIAL HANDLING

## WIRE WAGON® 510

WW510



**WE'VE GOT IT  
MADE IN AMERICA™**

**Conduit and wire cart.**

- Holds up to 14 - 2,500' spools or a combination of 2,500' and 1,000' spools
- Holds several hundred feet of conduit as well as all the additional materials and tools needed for your entire work day
- Designed with a full 24" x 60" metal top shelf for storage and assembly
- Cart includes 8" total lock casters
- 2,000 lb. capacity

### SPECIFICATIONS

MODEL #	STOCK #	DESCRIPTION		
WW510	56824801	Wire Wagon® 510		
	LENGTH	WIDTH	HEIGHT	WEIGHT
WW510	60.5"	29.5"	46.25"	191 lb.

## WIRE WAGON® 520

WW520



**WE'VE GOT IT  
MADE IN AMERICA™**

**MC cable and conduit cart.**

- Holds 4 spools of 1,000' MC cable
- Allows for different sizes and colors on one rack
- Comes standard with two sets of axles for wider than normal spools
- Eliminate spool jacks and the unnecessary set up and tear down time between pulls
- Cart includes 8" total lock casters
- Holds up to 1,000 ft. of conduit or strut
- 2,000 lb. capacity

### SPECIFICATIONS

MODEL #	STOCK #	DESCRIPTION		
WW520	56825001	Wire Wagon® 520		
	LENGTH	WIDTH	HEIGHT	WEIGHT
WW520	60"	52"	13"	125 lb.

# MATERIAL HANDLING

## WIRE WAGON® 530

WW530



 **WE'VE GOT IT  
MADE IN AMERICA™**

**Large spool cart.**

- Holds 8 spools up to 16" in diameter
- Storage for extra tools, spools and materials
- Easy to load and unload
- Cart includes 8" total lock casters
- 1,000 lb. capacity

### SPECIFICATIONS

MODEL #	STOCK #	DESCRIPTION	LENGTH	WIDTH	HEIGHT	WEIGHT
WW530	56825101	Wire Wagon® 530				
WW530			50"	29.5"	42"	155 lb.

## WIRE WAGON® 535

WW535



 **WE'VE GOT IT  
MADE IN AMERICA™**

**Large capacity wire cart.**

- Holds up to 20 – 500' spools of 12 AWG and 14 AWG or 6 -2500' spools of 12 AWG and 14 AWG
- Will hold up to 9 boxes of data cable or 6 - 1,000 ft. spools
- Extra storage shelf for tools, spools and materials
- Easy to load and unload, there are no axles or pins to remove
- Cart includes 8" total lock casters
- 1,000 lb. capacity

### SPECIFICATIONS

MODEL #	STOCK #	DESCRIPTION	LENGTH	WIDTH	HEIGHT	WEIGHT
WW535	56825201	Wire Wagon® 535				
WW535			50"	29.5"	42"	142 lb.

MATERIAL HANDLING | WIRE WAGON®

# MATERIAL HANDLING

## WIRE WAGON® 538

WW538



 **WE'VE GOT IT  
MADE IN AMERICA™**

### Service cart.

- Holds up to 12 – 500' spools of 12 AWG and 14 AWG
- Constructed with 5/8" solid steel bar to support almost any combination of wire spools
- Easy movement around the jobsite
- Folds flat in seconds for minimal storage
- Great for service trucks or vans

## SPECIFICATIONS

MODEL #	STOCK #	DESCRIPTION		
WW538	56825401	Wire Wagon® 538		
	LENGTH	WIDTH	HEIGHT	WEIGHT
WW538	32.5"	26.5"	36.5"	25.5 lb.

## WIRE WAGON® 550

WW550



 **WE'VE GOT IT  
MADE IN AMERICA™**

### Mobile print table and work station.

- No wasting time back and forth to a stationary print table
- Move your plans and materials right to the work area
- 1,000 lb. capacity
- Cart includes 8" total lock casters
- Multiple uses:
  - Mobile print table
  - Material shelf
  - Conduit rack
  - Portable work bench

## SPECIFICATIONS

MODEL #	STOCK #	DESCRIPTION		
WW550	56825501	Wire Wagon® 550		
	LENGTH	WIDTH	HEIGHT	WEIGHT
WW550	54"	32"	42"	180 lb.

# MATERIAL HANDLING

## 6 PACK MAC™ WIRE CART

PM06



 **WE'VE GOT IT  
MADE IN AMERICA™**

The 6 Pack Mac™ is a compact mobile wire dispensing cart that provides convenient storage, easy maneuverability, and seamless payoff for overall convenient use.

- Stores in one-third of the space of conventional dispensers
- Reel spindles fold and lock for convenient storage
- Fits through a 30" doorway
- Two 10" wheels with one 8" locking swivel caster for easy maneuverability
- Welded wire guides for easy payoff
- Stores up to (6) 2,500' spools (18" diameter) of wire

### SPECIFICATIONS

MODEL #	STOCK #	DESCRIPTION		
PM06	783350	6 PACK MAC™ Wire Cart		
LENGTH	WIDTH	HEIGHT	WEIGHT	
PM06	28.75"	39.5"	31.5"	81 lb.

## 10 PACK MAC™ WIRE CART

PM10



 **WE'VE GOT IT  
MADE IN AMERICA™**

The 10 Pack Mac™ is a mobile wire dispensing cart that provides convenient storage, easy maneuverability, and seamless payoff for overall convenient use.

- Handle/guide loop position controlled by plunger: 4-positions, no loose parts
- Spindles fold up & lock
- Mast swivels 360 degrees, but can be locked in fixed positions
- Mast may be removed for compact storage
- 4-heavy duty, locking 8" swivel casters
- Feed handle and guide loops are built into one part

### SPECIFICATIONS

MODEL #	STOCK #	DESCRIPTION		
PM10	783366	10 PACK MAC™ Wire Cart		
LENGTH	WIDTH	HEIGHT	WEIGHT	
PM10	33"	41"	56.5"	250 lb.



# MATERIAL HANDLING

MATERIAL HANDLING | CADDY MAC™

## CADDY MAC™ #1 DOLLY

CM01



Transports spools on spindles and works as a dolly. Wire is dispensed while laying flat.

- 1/2" solid spindles are attached to cart
- No loose pieces. Spindles lock into place, even during transport
- Spindles swing out to set position for convenient loading of wire spools
- Can be used with Handi Mac for extra storage

### SPECIFICATIONS

MODEL #	STOCK #	DESCRIPTION		
CM01	783398	CADDY MAC™ #1 Dolly		
LENGTH	WIDTH	HEIGHT	WEIGHT	
CM01	20"	26"	49"	50 lb.

 WE'VE GOT IT  
**MADE IN AMERICA™**

## CADDY MAC™ #2 DOLLY

CM02



CADDY MAC™ #2 Dolly holds 16 spools of #10 AWG or 24 spools of #12 AWG.

- Spindles can be easily removed for the occasional use of larger spools
- Inner spindles store in special loops which can hold four pieces and will not fall out during transportation
- Hinge design allows easy access to all spools for wire dispensing and folds for compact storage

### SPECIFICATIONS

MODEL #	STOCK #	DESCRIPTION		
CM02	783395	CADDY MAC™ #2 Dolly		
LENGTH	WIDTH	HEIGHT	WEIGHT	
CM02	14"	26"	49.5"	63 lb.

 WE'VE GOT IT  
**MADE IN AMERICA™**

# MATERIAL HANDLING

## CADDY MAC™ #3 DOLLY

CM03



CADDY MAC™ #3 Dolly is a versatile wire cart that doubles as a dolly.

- Uses five 5/8" diameter spindles
- Unique spindle locking system, no loose clips
- Storage loops retain up to 5 spindles
- Dual wire guides
- Large spool capacity

### SPECIFICATIONS

MODEL #	STOCK #	DESCRIPTION		
CM03	783400	CADDY MAC™ #3 Dolly		
LENGTH	WIDTH	HEIGHT	WEIGHT	
CM03	21.5"	26.5"	47.25"	78 lb.



## SPOOL MAC™ CART

SM-01



Wire payoff cart.

- All steel frame construction
- 10" wheels for easy transport over rough terrain
- Rollers on spool arm allow for smooth reel rotation and easy payoff
- No loose pieces to account for
- Folding design allows for compact storage
- Fits through 32" doorways
- 350 lb. (160 kg) load capacity

### SPECIFICATIONS

MODEL #	STOCK #	DESCRIPTION		
SM-01	783444	SPOOL MAC™ Cart		
LENGTH	WIDTH	HEIGHT	WEIGHT	
SM-01	16"	31.5"	63.5"	80 lb.



# MATERIAL HANDLING

## HANDI MAC™

HM-01



Wire dispenser.

- Provides extra spool storage for CADDY MAC™ #1 or as a free standing wire dispenser
- Holds up to 8 additional spools
- Spindles are made of sturdy 3/8" steel bar

### SPECIFICATIONS

MODEL #	STOCK #	DESCRIPTION	LENGTH	WIDTH	HEIGHT	WEIGHT
HM-01	783490	HANDI MAC™ Wire Dispenser				
HM-01			22.5"	12.5"	10"	7.5 lb.

## WIRESMART™ HAND CADDY

MH8110



**MH8110 - Cable Dispenser**

- Includes 2-brackets to mount to floor or stud
- Versatility of 3 items in 1
- Square-tube steel with a premium powder coat finish
- Convenient carry handle included
- Max weight: 50 lb. with arm, 100 lb. with reel

MH8120



**MH8120 - Cable Dispenser Add-On**

- Mounts to cable dispenser MH8110 (sold separately)
- Stacks easily, no tools required
- Allows for double the capacity
- Inside capacity: 5.5" min. inside coil diameter
- Outside capacity: 17" min. outside coil diameter
- Max weight (separate unit): 50 lb.

MH8010



**MH8010 - Hand Caddy**

- Convenient hand carrying design
- Square-tube steel with a premium powder coat finish
- Shipped knocked down, takes up less shelf space
- Convenient one hand portability

### SPECIFICATIONS

MODEL #	DESCRIPTION	INSIDE CAPACITY	OUTSIDE CAPACITY	MAX WEIGHT
MH8110	Cable Dispenser	5.5" Min. Inside Coil Diameter	17" Min. Outside Coil Diameter	50 lb. W/Arms, 100 lb. W/Reel
MH8120	Cable Dispenser Add-On	5.5" Min. Inside Coil Diameter	17" Min. Outside Coil Diameter	50 lb. Each Dispenser, 100 lb. Total
MH8010	Hand Caddy	8 Max. Spools 7" Diameter X 5" Wide	4 Max. Spools 7" Diameter X 6-10" Wide	--

# MATERIAL HANDLING

## MAC RACK I™ & MAC RACK II™



Sumner Mac Rack™ carts are mobile jobsite and conduit and pipe storage carts.

- 1,000 lbs. weight capacity
- Double wall square tubing
- Eight storage sections
- Arms fold easily with plunger pins for compact storage
- Shipped assembled with 6" heavy-duty casters
- Durable powder coat finish
- Patented stacking feature: Stack similar carts together or with other Stacking Mac carts
- Mac Rack II™ cart has a mesh deck for material storage

MRACKII



### SPECIFICATIONS

MODEL #	STOCK #	DESCRIPTION	LOAD CAPACITY
MRACKI	783317	Mac Rack I™	1,000 lb.
MRACKII	783299	Mac Rack II™ with Mesh Base	1,000 lb.



# MATERIAL HANDLING

## HANGER MAC™

### HMACII



The Summer Hanger Mac™ cart is a patented pipe hanger and transportation solution.

- Eliminates multiple handling and reduces fabrication transport costs
- Available with or without wire mesh base
- Hanger Mac™ cart holds (40) 6-8" and (120) 2-4" pipe hangers
- Patented stacking feature: Stack similar carts together or with other Stacking Mac carts
- Folds for compact storage and transportation without tools

### SPECIFICATIONS

MODEL #	STOCK #	DESCRIPTION
HMACI	785650	HANGER MAC™ without mesh base
HMACII	785651	HANGER MAC™ with mesh base



# MATERIAL HANDLING

## PIPE MAC™

### PMAC



The Sumner Pipe Mac™ cart is purposely built to transport large pipes and pipe bundles.

- Transports 2,000 lbs. of pipe individually or up to a height of 34"
- Six 6" heavy-duty casters
- Removable posts for compact storage
- Stacks when not in use
- Patented stacking feature: Stack similar carts together or with other Stacking Mac carts
- Includes Vee Attachment to prevent pipe from rolling when in motion
- Vee Attachment easily slips over the four post holders – no tools required

### PMACVEE



## SPECIFICATIONS

MODEL #	STOCK #	DESCRIPTION	LOAD CAPACITY
PMAC	783230	PIPE MAC™ w/Vee	2,000 lb.
OPTIONAL ACCESSORY			
PMACVEE	783240	Pipe Mac™ Vee Attachment only	---

## BUNDLE MAC™

### BMAC



The Sumner Bundle Mac™ cart is designed to transport large quantities of conduit, strut, threaded rod, PVC pipe or copper tubing in one large cradle.

- Arms fold easily with plunger pins for compact storage
- 1,000 lbs. load capacity
- Patented stacking feature: Stack similar carts together or with other Stacking Mac carts
- Shipped assembled with 6" heavy-duty casters

## SPECIFICATIONS

MODEL #	STOCK #	DESCRIPTION	LOAD CAPACITY
BMAC	783320	BUNDLE MAC™	1,000 lb.

# MATERIAL HANDLING

## STOR MAC™ STORAGE CABINETS

### SM30



Security storage cabinet.

- Steel wire mesh
- Four 6" heavy duty casters (standard)
- For high visibility storage
- Removable shelves for adjustable storage
- Lockable doors
- Load capacity 1,500 lb.

### SPECIFICATIONS

MODEL #	STOCK #	DESCRIPTION	LENGTH	WIDTH	HEIGHT	WEIGHT
SM30	785920	STOR MAC™ 30	33.75"	31.5"	58"	210 lb.
SM48	785921	STOR MAC™ 48	33.75"	51.5"	58"	310 lb.
SM60	784920	STOR MAC™ 60	33.75"	63.5"	58"	345 lb.

### SM48



### SM60



 **WE'VE GOT IT  
MADE IN AMERICA™**

# MATERIAL HANDLING

## KNOCK DOWN STOR MAC™ STORAGE CABINET

**KDSM-60**



A collapsible security storage cabinet for those who require high visibility of contents.

- Quickly collapses and assembles in under 5 minutes
- Four 6" heavy duty casters (standard)
- Reinforced frame and door
- Removable shelves for adjustable storage
- Load capacity 1,500 lb.
- Lockable doors work with puck or pad locks

### SPECIFICATIONS

MODEL #	STOCK #	DESCRIPTION	HEIGHT	WIDTH	LENGTH	WEIGHT
KDSM-60	786920	Knock Down STOR MAC™				
KDSM-60	58.5"	62.5"	32"	425 lb.		

 **WE'VE GOT IT  
MADE IN AMERICA™**



**MATERIAL HANDLING | KD STOR MAC™**

# MATERIAL HANDLING

## TAINER MAC™ 60

### TMAC60



A mobile, heavy-duty stacking container.

- Transports 1,500 lb. / 680 kg of material
- Large storage capacity
- Four 6" heavy-duty lockable casters
- Posts for stacking & steering
- Fits through 36" (91 cm) doorway
- Stacks with other Sumner Stacking Macs

### SPECIFICATIONS

MODEL #	STOCK #	DESCRIPTION	LENGTH	WIDTH	HEIGHT	WEIGHT
TMAC60	784990	TAINER MAC™ 60				
TMAC60			56"	32"	40"	200 lb.



# MATERIAL HANDLING

## WELDBOX™ 3617

WB3617



The ideal storage chest for all welders & electricians.

- Two-point latching system requires only one lock
- Caster ready
- 16-gauge steel construction
- Powder coat finish for superior durability and corrosion resistance

### SPECIFICATIONS

MODEL #	STOCK #	DESCRIPTION		
WB3617	779928	WELDBOX™ 3617		
LENGTH	WIDTH	HEIGHT	WEIGHT	
WB3617	22.5"	36"	17"	97.9 lb.

## WELDBOX™ 2008

WB2008



Tool storage box.

- Powder coat finish for superior durability and corrosion resistance

### SPECIFICATIONS

MODEL #	STOCK #	DESCRIPTION		
WB2008	779910	WELDBOX™ 2008		
LENGTH	WIDTH	HEIGHT	WEIGHT	
WB2008	9.5"	20.125"	8.5"	12.1 lb.

## WELDBOX™ 3010

WB3010



Storage box.

- 16-gauge steel construction
- Powder-coat finish for superior durability and corrosion resistance

### SPECIFICATIONS

MODEL #	STOCK #	DESCRIPTION		
WB3010	799910	WELDBOX™ 3010		
LENGTH	WIDTH	HEIGHT	WEIGHT	
WB3010	29.5"	13.5"	10"	30.4 lb.



# MATERIAL HANDLING

## BI-FOLD CABINET

CB603065



Bi-fold cabinet gives you unrestricted access to your tools with heavy-duty shelves and a single locking point.

- Recessed lock housing for protection against theft with one-time lock installation
- Powder coat finish for superior durability and corrosion resistance
- Heavy duty 16 gauge box construction
- Welded shelves
- Heavy-duty hinges to resist break in
- Casters included

### SPECIFICATIONS

MODEL #	STOCK #	DESCRIPTION	LENGTH	WIDTH	HEIGHT	WEIGHT
CB603065	59822701	Bi-Fold Cabinet	62.5"	30"	63.5"	503 lb.

## TWO DOOR CABINET

CB602460



Two door cabinet gives you two ways to store your tools. With heavy-duty shelves and a large vertical storage area, you can easily organize and secure your tools.

- Recessed lock housing for protection against theft with one-time lock installation
- Four-way skids allow access from any side, making it easier and faster to transport
- Powder coat finish for superior durability and corrosion resistance
- Caster-ready 7 gauge steel skids
- Heavy-duty 16 gauge box construction
- Welded shelves
- Heavy-duty hinges to resist break in
- Casters not included

### SPECIFICATIONS

MODEL #	STOCK #	DESCRIPTION	LENGTH	WIDTH	HEIGHT	WEIGHT
CB602460	59822801	Two Door Cabinet	60.125"	24.25"	60.75"	366 lb.

# MATERIAL HANDLING

## PIANO BOX

**PB603049**



Piano boxes offer, at a glance, storage for both small and large tools, making it possible to organize and secure your livelihood, save time, and reduce costs on the jobsite.

- Recessed lock housing for protection against theft with one-time lock installation
- Four-way skids allow access from any side, making it easier and faster to transport
- Powder coat finish for superior durability and corrosion resistance
- Caster-ready 7 gauge steel skids
- Heavy-duty 16 gauge box construction
- Welded shelves
- Heavy-duty hinges to resist break in
- Casters not included

### SPECIFICATIONS

MODEL #	STOCK #	DESCRIPTION		
PB603049	59822401	Piano Box		
	LENGTH	WIDTH	HEIGHT	WEIGHT
PB603049	30"	60"	48.5"	337 lb.

## PIANO BOX

**PB483048**



Piano boxes offer, at a glance, storage for both small and large tools, making it possible to organize and secure your livelihood, save time, and reduce costs on the jobsite.

- Recessed lock housing for protection against theft with one-time lock installation
- Four-way skids allow access from any side, making it easier and faster to transport
- Powder coat finish for superior durability and corrosion resistance
- Caster-ready 7 gauge steel skids
- Heavy-duty 16 gauge box construction
- Welded shelves
- Heavy-duty hinges to resist break in
- Casters not included

### SPECIFICATIONS

MODEL #	STOCK #	DESCRIPTION		
PB483048	59822301	Piano Box		
	LENGTH	WIDTH	HEIGHT	WEIGHT
PB483048	30"	48"	48"	287 lb.

# MATERIAL HANDLING

## PIANO BOX

**PB603034**



Piano boxes offer, at a glance, storage for both small and large tools, making it possible to organize and secure your livelihood, save time, and reduce costs on the jobsite.

- Recessed lock housing for protection against theft with one-time lock installation
- Four-way skids allow access from any side, making it easier and faster to transport
- Powder coat finish for superior durability and corrosion resistance
- Caster-ready 7 gauge steel skids
- Heavy-duty 16 gauge box construction
- Welded shelves
- Heavy-duty hinges to resist break in
- Casters not included

### SPECIFICATIONS

MODEL #	STOCK #	DESCRIPTION	LENGTH	WIDTH	HEIGHT	WEIGHT
PB603034	59822201	Piano Box				
PB603034			30"	60"	34"	282 lb.

## FIELD OFFICE

**F0604482**



Field office offers a large workstation with shelved storage and a single locking point, allowing you to control and secure any jobsite.

- Recessed lock housing for protection against theft with one-time lock installation
- Four-way skids allow access from any side, making it easier and faster to transport
- Powder coat finish for superior durability and corrosion resistance
- Caster-ready 7 gauge steel skids
- Heavy-duty 16 gauge box construction
- Welded shelves
- Heavy-duty hinges to resist break in
- Casters not included
- Adjustable and removable split shelves let you organize your storage in the lower cabinets
- Dual gas springs for smooth, one-handed lift, one spring locks securely in place

### SPECIFICATIONS

MODEL #	STOCK #	DESCRIPTION	LENGTH	WIDTH	HEIGHT	WEIGHT
F0604482	59822501	Field Office				
F0604482			63.5"	42.5"	80"	772 lb.

# MATERIAL HANDLING

## COMPACT CHEST

**CC482423**



Compact chest is a highly mobile storage vault. With the perfect profile for a truck bed and steel fork lift skids, this box will become your workhorse.

- Recessed lock housing for protection against theft with one-time lock installation
- Four-way skids allow access from any side, making it easier and faster to transport
- Powder-coat finish for superior durability and corrosion resistance
- Caster-ready 7 gauge steel skids
- Heavy-duty 16 gauge box construction
- Welded shelves
- Heavy-duty hinges to resist break in
- Casters not included

### SPECIFICATIONS

MODEL #	STOCK #	DESCRIPTION		
CC482423	59822601	Compact Chest		
LENGTH	WIDTH	HEIGHT	WEIGHT	
CC482423	48"	24"	27.75"	170 lb.

## MINI COMPACT CHEST

**CC191932**



Mini compact chest is a highly mobile storage solution that stores easily in about any location.

- Recessed lock housing for protection against theft with one-time lock installation
- Four-way skids allow access from any side, making it easier and faster to transport
- Powder-coat finish for superior durability and corrosion resistance
- Caster-ready 7 gauge steel skids
- Heavy-duty 16 gauge box construction
- Welded shelves
- Heavy-duty hinges to resist break in
- Casters not included

### SPECIFICATIONS

MODEL #	STOCK #	DESCRIPTION		
CC191932	6303601	Mini Compact Chest		
LENGTH	WIDTH	HEIGHT	WEIGHT	
CC191932	31"	18"	17.5"	82 lb.

# MATERIAL HANDLING

## TWO SHELF UTILITY CARTS

### UCTS-LG



Designed to help make transporting materials and items around the job site easier and more efficient.

- 550 lb. load capacity
- Handle includes built in storage for nuts, bolts, screws, and other small items

### UCTS-SM



## SPECIFICATIONS

MODEL #	STOCK #	DESCRIPTION		
UCTS-LG	65240240	Large Utility Cart		
UCTS-SM	65240340	Small Utility Cart		
	LENGTH	WIDTH	HEIGHT	WEIGHT
UCTS-LG	46.75"	25.5"	33.5"	45 lb.
UCTS-SM	40.7"	16.9"	33.5"	33 lb.



# MATERIAL HANDLING

## CARTLOCKER™ KITS

### UCLX-LG



Make your Southwire two shelf utility cart a mobile lockable storage solution with Southwire's CartLocker™ Kits. Specifically designed to fit and install to your Southwire utility cart easily and keep items safe, secure, and out of sight.

- Designed to fit Southwire's large and small two shelf utility carts
- Keep items safe, secure, and out of sight
- Heavy-duty powder coated steel panels and door
- Lockable door works with puck and pad locks
- No drilling required. Easily install CartLocker™ Kit using pre-existing holes in utility cart
- Xtreme™ option has accessories including 2 bolt on trays, 2 large hooks, and 2 small hooks

## SPECIFICATIONS

MODEL #	STOCK #	DESCRIPTION		
UCLX-LG	66101840	CartLocker™ Xtreme™ Large Kit		
UCLX-SM	66222140	CartLocker™ Xtreme™ Small Kit		
UC-LGCL	66321440	CartLocker™ Large Kit		
UC-SMCL	66351740	CartLocker™ Small Kit		
TSUCLX-LG	66777440	Large Utility Cart with CartLocker™ Xtreme™ Large Kit		
TSUCLX-SM	66149040	Small Utility Cart with CartLocker™ Xtreme™ Small Kit		
TSUCL-LG	66149640	Large Utility Cart with CartLocker™ Large Kit		
TSUCL-SM	66159540	Small Utility Cart with CartLocker™ Small Kit		
LHCL	66165240	Large Hooks for CartLocker™ (2 pack)		
SMCL	66179340	Small Hooks for CartLocker™ (2 pack)		
SCDTCL-LG	66183540	Spray Can and Drill Holder Tray for Large CartLocker™		
SCDTCL-SM	66185040	Spray Can and Drill Holder Tray for Small CartLocker™		
THTCL-LG	66186840	Tool Holder Tray for Large CartLocker™		
THTCL-SM	66201540	Tool Holder Tray for Small CartLocker™		
	LENGTH	WIDTH	HEIGHT	WEIGHT
UCLX-LG	35"	19"	4.5"	60 lb.
UCLX-SM	28"	19"	4.5"	51 lb.
UC-LGCL	35"	19"	4.5"	52 lb.
UC-SMCL	28"	19"	4.5"	42 lb.
TSUCLX-LG	46.75"	25.5"	33.5"	105 lb.
TSUCLX-SM	40.7"	16.9"	33.5"	84 lb.
TSUCL-LG	46.75"	25.5"	33.5"	97 lb.
TSUCL-SM	40.7"	16.9"	33.5"	75 lb.
LHCL	1"	5"	10.5"	.4 lb.
SMCL	1"	3.5"	6"	.2 lb.
SCDTCL-LG	3.75"	16"	1"	2.4 lb.
SCDTCL-SM	3.5"	9.5"	1"	1.5 lb.
THTCL-LG	3.5"	16"	3"	.8 lb.
THTCL-SM	3"	9.5"	3"	.5 lb.



**Southwire™**

# TOOLS & EQUIPMENT CATALOG

**get social with us:**



**/SOUTHWIRETOOLS**



**/SOUTHWIRE-COMPANY**



**@SOUTHWIRETOOLS**



**@SOUTHWIRE**

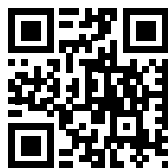

SCAN TO LEARN MORE

**WWW.SOUTHWIRE.COM | 1-855-SWT00LS**

All Trademarks or Registered Trademarks (TM/®) are owned or licensed by Southwire Company.  
Any other TM/®- Trademark or Registered Trademark of Southwire Company.

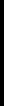

TOOLING & EQUIPMENT SALES  
SOUTH AFRICA  
1-855-555-5555